

high life

ROLLOVER *collection*















design yourself

WAGNER[®]





Erklärung der Abkürzungen und Piktogramme

Explanation of abbreviations and pictograms

Explication des abréviations et des pictogrammes

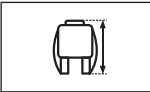
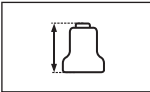
	Tragkraft Load capacity Capacité de charge
1x	Lose, unverpackt Bulk, unpacked En vrac, non-emballé
	SB-verpackt Packaged for self-service Emballé pour le libre-service
	Schlauchverpackt In polyathylen bag En sachet polyéthylène
	Farbe Colour Couleur
Code	Artikelnummer Article number Numéro d'article
	Befestigungen für Möbelrollen Fixing elements for furniture castors Fixations pour roulettes pour meubles
	Befestigungen für Drehstuhl-Doppelrollen Fixing elements for twin wheel castors for swivel chairs Fixations pour roulettes à double roue pour chaises pivotantes
	Befestigungen für Apparaterollen Fixing elements for equipment castors Fixations pour roulettes d'appareils
EAN-Code 4001073 ...	EAN 13-Code, 4001073, wird durch 6 Ziffern der Tabelle ergänzt EAN 13-Code, 4001073, is completed by the 6 numbers listed in the table EAN 13-Code, 4001073, est complété par les 6 chiffres indiqués dans le tableau
	Soft-Lauffläche für harte Böden, z.B. Parkett, Laminat, Fliesen Soft tread for hard floors, e. g. parquet, laminate, tiles Surface soft pour sols durs, p. ex. parquet, stratifié, carreaux
	Ultrasoft Ultrasoft Ultrasoft
	Gleitlager Plain bearing Palier lisse
	Rollenlager Roller bearing Palier à rouleaux
	Kugellager Ball bearing Roulement à billes

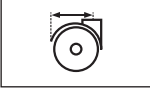
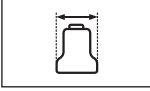
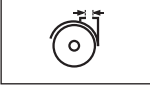
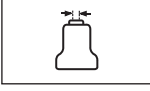
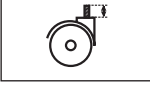
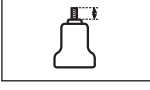
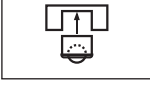
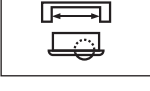
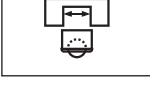
Erklärung der Abkürzungen und Piktogramme
 Explanation of abbreviations and pictograms
 Explication des abréviations et des pictogrammes

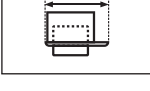
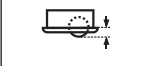
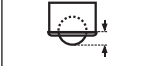
	Möbelrolle Bauhöhe Furniture castor total height Roulette pour meubles hauteur totale		Möbelgleiter Bauhöhe Glider for furniture total height Patin pour meubles hauteur totale
	Möbelrolle Breite Furniture castor width Roulette pour meubles largeur		Möbelgleiter Durchmesser Glider for furniture diameter Patin pour meubles diamètre
	Möbelrolle Störkreis Furniture castor collision circle Roulette pour meubles zone de travail		Möbelgleiter Durchmesser Standfläche Glider for furniture diameter base Patin pour meubles diamètre base
	Möbelrolle mit Rückenloch Furniture castor with back-hole Roulette pour meubles avec trou au dos		Möbelgleiter Rückenlochdurchmesser Glider for furniture diameter back-hole Patin pour meubles diamètre trou au dos
	Möbelrolle mit Befestigung Furniture castor with fixing element Roulette pour meubles avec fixation		Möbelgleiter mit Befestigung Glider for furniture with fixing element Patin pour meubles avec fixation
	Roller-Mini Bautiefe Roller-Mini installation depth Roller-Mini profondeur		Roller-Mini BSR Bautiefe Roller-Mini BSR installation depth Roller-Mini BSR profondeur
	Roller-Mini Lochdurchmesser Roller-Mini hole diameter Roller-Mini diamètre trou		Roller-Mini BSR Lochdurchmesser Roller-Mini BSR hole diameter Roller-Mini BSR diamètre trou
	Roller-Mini Durchmesser Roller-Mini diameter Roller-Mini diamètre		Roller-Mini BSR Durchmesser Roller-Mini BSR diameter Roller-Mini BSR diamètre
	Roller-Mini Bauhöhe Roller-Mini total height Roller-Mini hauteur totale		Roller-Mini BSR Bauhöhe Roller-Mini BSR total height Roller-Mini BSR hauteur totale

Im Sinne technischen Fortschritts behalten wir uns Konstruktionsänderungen und die Verwendung anderer Materialien ausdrücklich vor. Katalogabbildungen und andere beschreibende Aussagen sind daher unverbindlich.







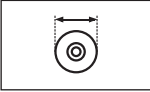
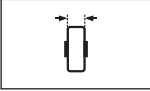
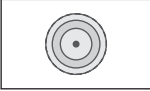
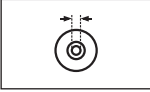
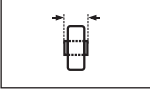

We reserve the right to make changes concerning construction and to use other technically improved materials due to technical progress. Therefore pictures and article descriptions are not binding.

Dans le cas d'améliorations techniques, nous nous réservons le droit de modifier la construction ainsi que d'employer d'autres matériaux. Les images et les descriptions sont sans obligation.

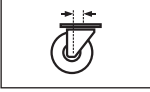
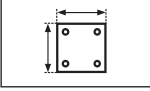
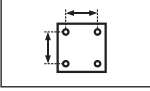
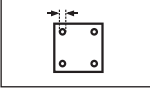
Erklärung der Abkürzungen und Piktogramme

Explanation of abbreviations and pictograms

Explication des abréviations et des pictogrammes

	Raddurchmesser Diameter of wheel Diamètre de la roue
	Radbreite Wheel width Largeur de la roue
	Fadenschutz Thread guard Pare-fils
	Apparaterollen / Transportgeräterollen Achsloch Equipment castors / Transport equipment castors axle hole Roulettes d' appareil / Roulettes de transport trou d' axe
	Apparaterollen / Transportgeräterollen Nabenlänge Equipment castors / Transport equipment castors hub length Roulettes d' appareil / Roulettes de transport longueur du moyeu
	Apparaterollen / Transportgeräterollen Bauhöhe Equipment castors / Transport equipment castors total height Roulettes d' appareil / Roulettes de transport hauteur totale
	Apparaterollen / Transportgeräterollen Ausladung Equipment castors / Transport equipment castors offset Roulettes d' appareil / Roulettes de transport portée
	Apparaterollen / Transportgeräterollen Plattengröße Equipment castors / Transport equipment castors size of plate Roulettes d' appareil / Roulettes de transport taille de la platine
	Apparaterollen / Transportgeräterollen Plattenlochabstand Equipment castors / Transport equipment castors plate hole distance Roulettes d' appareil / Roulettes de transport distance trou platine
	Apparaterollen / Transportgeräterollen Lochgröße Equipment castors / Transport equipment castors hole size Roulettes d' appareil / Roulettes de transport taille du trou
	Apparaterollen / Transportgeräterollen Rückenloch Bauhöhe Equipment castors / Transport equipment castors back-hole total height Roulettes d' appareil / Roulettes de transport trou au dos hauteur totale
	Apparaterollen / Transportgeräterollen Rückenlochmaß Equipment castors / Transport equipment castors back-hole measure Roulettes d' appareil / Roulettes de transport mesure trou au dos
	Apparaterollen / Transportgeräterollen Rückenlochdurchmesser Equipment castors / Transport equipment castors back-hole diameter Roulettes d' appareil / Roulettes de transport diamètre trou au dos
	Apparaterollen / Transportgeräterollen Rückenloch Ausladung Equipment castors / Transport equipment castors back-hole offset Roulettes d' appareil / Roulettes de transport portée trou au dos
	Apparaterollen / Transportgeräterollen Rückenloch Stiftmaß Equipment castors / Transport equipment castors back-hole stem dimension Roulettes d' appareil / Roulettes de transport mesure de la tige trou au dos

Inhaltsverzeichnis

Contents

Sommaire

	Möbelrollen Furniture castors Roulettes pour meubles	Seite page page	6-25 6-25 6-25
	Möbelrollen RO 73/METRIS/RONDO Furniture castors RO 73/METRIS/RONDO Roulettes pour meubles RO 73/METRIS/RONDO	Seite page page	26-29 26-29 26-29
	Möbelgleiter Gliders for furniture Patins pour meubles	Seite page page	30-33 30-33 30-33
	Befestigungen für Möbelrollen Fixing elements for furniture castors Fixations pour roulettes pour meubles	Seite page page	34-43 34-43 34-43
	Drehstuhl-Doppelrollen/Befestigungen Twin-wheel castors for swivel chairs/fixing elements Roulettes à double roue pour chaises pivotantes/fixations	Seite page page	44-51 44-51 44-51
	Roller-Mini Roller-Mini Roller-Mini	Seite page page	52-67 52-67 52-67
	Designrollen/Holzräder Design castors/wooden wheels Roulettes design/Roues en bois	Seite page page	68-75 68-75 68-75
	Möbel-Bockrollen/Möbel-Lenkrollen/Möbel-Kastenrollen Fixed castors for furniture/Swivel castors for furniture/Castors for bed frame Roulettes fixes/Roulettes pivotantes/Roulettes de caissons pour meubles	Seite page page	76-103 76-103 76-103
	Apparaterollen/Ersatzräder Equipment castors/Spare wheels Roulettes d'appareil/Roues de rechange	Seite page page	104-117 104-117 104-117
	Befestigungen für Apparaterollen Fixing elements for equipment castors Fixations pour roulettes d'appareil	Seite page page	118-123 118-123 118-123
	Transportgeräterollen/Ersatzräder Swivel castors for transport equipment/Spare wheels Roulettes de transport/Roues de rechange	Seite page page	124-147 124-147 124-147
	Scheiben-/Speichenräder/luftbereifte Räder und Zubehör Disk-/Spokewheels/Pneumatic wheels and accessories Roues à disque-/rayons/Roues avec pneu et accessoires	Seite page page	148-161 148-161 148-161

Im Sinne technischen Fortschritts behalten wir uns Konstruktionsänderungen und die Verwendung anderer Materialien ausdrücklich vor. Katalogabbildungen und andere beschreibende Aussagen sind daher unverbindlich.

We reserve the right to make changes concerning construction and to use other technically improved materials due to technical progress. Therefore pictures and article descriptions are not binding.

Dans le cas d'améliorations techniques, nous nous réservons le droit de modifier la construction ainsi que d'employer d'autres matériaux. Les images et les descriptions sont sans obligation.

Möb

elrollen

*Furniture castors
Roulettes pour meubles*



Möbel-Kugelrolle mit Anschraubplatte, Gehäuse: Zinkdruckguss, verchromt, Rad: hochwertiger Kunststoff, Lauffläche: soft
 Ball castor for furniture, with screw-on plate, casing: die cast zinc, chromium-plated, wheel: high-quality plastic, tread: soft
 Roulette sphérique pour meubles, support : zinc coulé sous pression, chromée, roue : plastique de haute qualité, surface : soft

38 48	32 40	soft X X	X X	53 60	38 17	38x38 38x38	27 27	5 5	30 50				1x		PE	Code	EAN-Code 4001073 ...
													X			01 0015 01	...016130
													X			01 0013 01	...016031



Möbel-Kugelrolle mit Anschraubplatte, Gehäuse: Zinkdruckguss, schwarz, Rad: hochwertiger Kunststoff, Lauffläche: soft
 Ball castor for furniture, with screw-on plate, casing: die cast zinc, black, wheel: high-quality plastic, tread: soft
 Roulette sphérique pour meubles, support : zinc coulé sous pression, noir, roue : plastique de haute qualité, surface : soft

38 48	32 40	soft X X	X X	53 60	14 17	38x38 38x38	27 27	5 5	30 50				1x		PE	Code	EAN-Code 4001073 ...
													X			01 0017 01	...340471
													X			01 0016 01	...340785



Möbel-Doppelrolle aus Zinkdruckguss, hochglanz-verchromt,
2 Polyamid-Räder, schwarz

Twin wheel castor for furniture, casing: die-cast zinc, high-gloss chromium-plated, 2 polyamid wheels, black

Roulette à double roue pour meubles, support : zinc coulé sous pression, chromé-brillant, 2 roues en polyamide, noires

																1x			Code	EAN-Code
50	60	53	45	8	X	55										X			01 0021 01	4001073 ...
																				...016215



Möbel-Doppelrolle aus hochwertigem Kunststoff, wahlweise mit oder ohne Anschraubplatte, schwarz, Lauffläche: soft
 Twin wheel castor for furniture, made of high-quality plastic, alternatively with or without screw-on plate, black, tread: soft
 Roulette à double roue pour meubles, en plastique de haute qualité, au choix avec ou sans platine à visser, noire, surface : soft

													1x			Code	EAN-Code
40	39	X	45	39	8					X	35		X			01 0726 01	...019124
50	55	X	56	46	8					X	50		X			01 0722 01	...019117



Möbel-Doppelrolle aus hochwertigem Kunststoff, mit Radfeststeller, wahlweise mit oder ohne Anschraubplatte, schwarz, Lauffläche: soft
 Twin wheel castor for furniture with brake, made of high-quality plastic, alternatively with or without screw-on plate, black, tread: soft
 Roulette à double roue pour meubles, avec blocage, en plastique de haute qualité, au choix avec ou sans platine à visser, noire, surface : soft

													1x			Code	EAN-Code
40	39	X	45	51	8					X	35		X			01 0727 01	...044713
50	55	X	56	58	8					X	50		X			01 1728 01	...020557
50	55	X	56	58		42x42	32	4,5			50			4		02 1728 88	...020748





Möbel-Doppelrolle aus hochwertigem Kunststoff, hochglanz-verchromt, 2 Polyamid-Räder, schwarz

Twin wheel castor for furniture, made of high-quality plastic, high-gloss chromium-plated, 2 polyamid wheels, black

Roulette à double roue pour meubles, en plastique de haute qualité, chromée-brillante, 2 roues en polyamide, noires

Ø	W	H	Ø	Ø	+	kg									1x		PE	Code	EAN-Code
40	39	46	40	8	X	35									X			01 1524 01	...043822
50	55	56	47	8	X	50									X			01 0022 01	...016314



Möbel-Doppelrolle aus hochwertigem Kunststoff, mit Radfeststeller, hochglanz-verchromt, 2 Polyamid-Räder, schwarz

Twin wheel castor for furniture, with brake, made of high-quality plastic, high-gloss chromium-plated, 2 polyamid wheels, black

Roulette à double roue pour meubles, avec blocage, chromée-brillante, 2 roues en polyamide, noires

Ø	W	H	Ø	Ø	+	kg									1x		PE	Code	EAN-Code
40	39	45	52	8	X	35									X			01 1526 01	...020328
50	54	56	59	8	X	50									X			01 1028 01	...020625



high

8

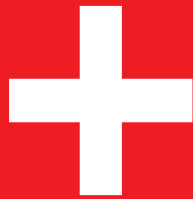

8



Der obere Teil der Befestigung stellt die Verbindung zum Möbel her.

Der untere Teil der Befestigung stellt die genormte Verbindung zur Rolle her.

Zusammenstecken – fertig. Ergebnis: Jede Rolle passt zu jeder Befestigung und somit zu jeder Art von Möbel.

The upper part of the fixing element makes the normed connection with the furniture.

The bottom part of the fixing element makes the normed connection with the castor.

Plug them together – ready. Result: Every castor fits to every fixing element and thus to any kind of furniture.

La partie supérieure de la fixation fait la connexion avec le meuble.

La partie inférieure de la fixation fait la connexion standardisée avec la roulette.

Assembler – terminé. Résultat : Chaque roulette est compatible avec chaque fixation et donc avec chaque type de meuble.

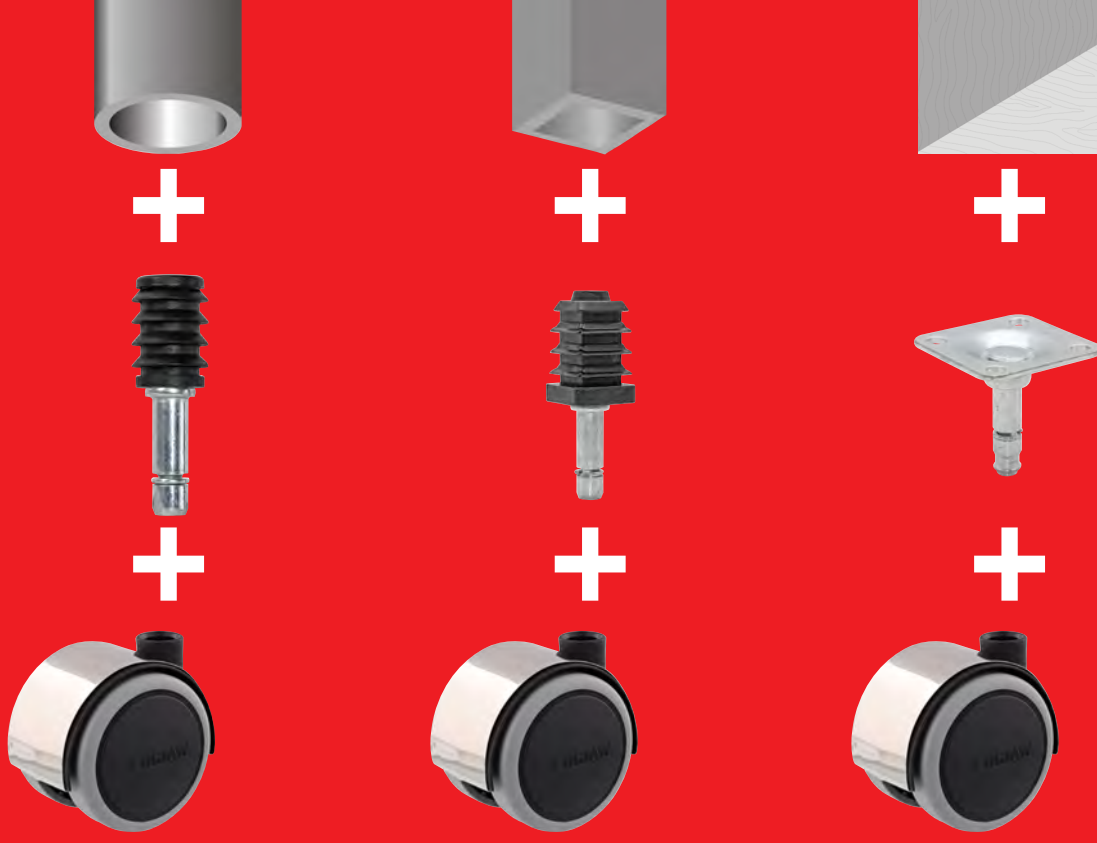

system

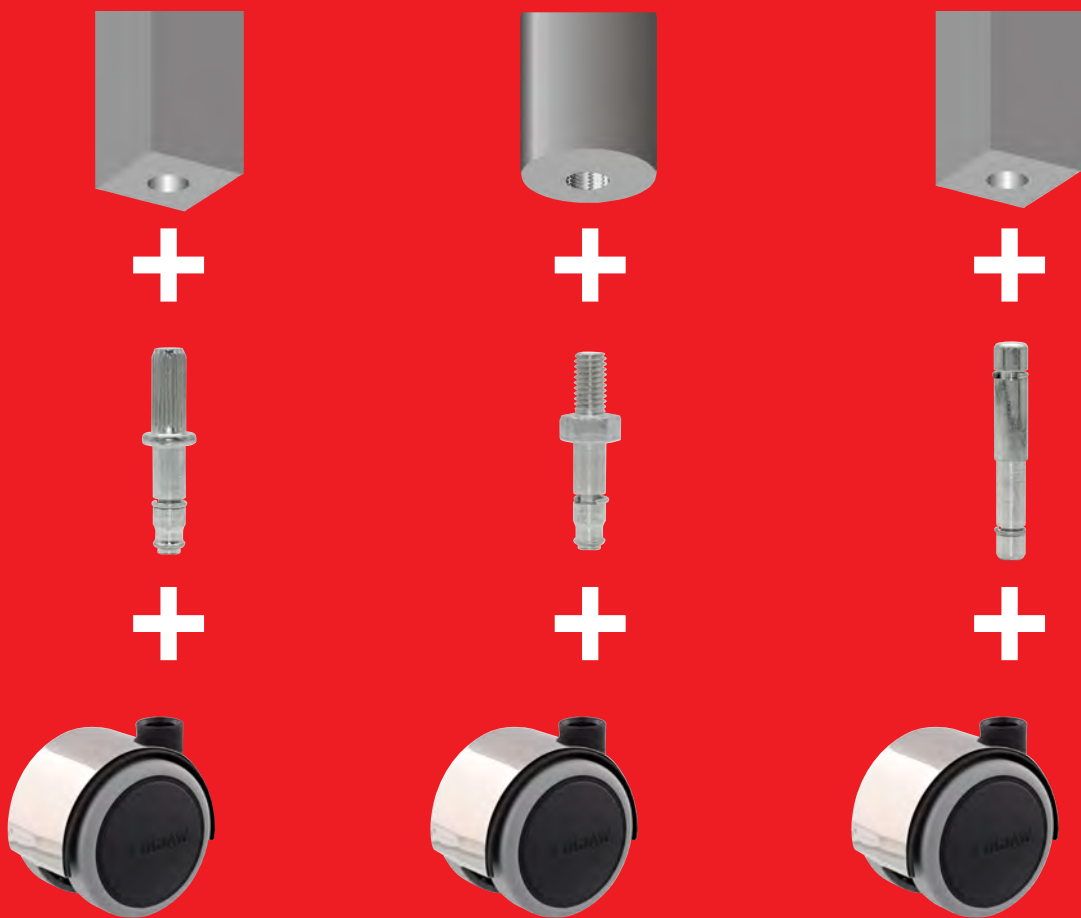



Möbel-Doppelrolle KONKAV aus hochwertigem Kunststoff, schwarz

Twin wheel castor for furniture KONKAV, made of high-quality plastic, black

Roulette á double roue pour meubles KONKAV, en plastique de haute qualité, noire

														1x			Code	EAN-Code
50	44		50	45	8	X		50						X			01 1423 01	...016352
50	44	X	50	45	8	X		50						X			01 1428 01	...133578



Möbel-Doppelrolle LAQUE aus hochwertigem Kunststoff, hochglänzend, schwarz oder weiß

Twin wheel castor for furniture LAQUE, made of high-quality plastic, high-gloss, black or white

Roulette á double roue pour meubles LAQUE, en plastique de haute qualité, très brillant, noire ou blanche

														1x			Code	EAN-Code
50	53	50	45	8	X		50							X			01 3023 01	...019322



Möbel-Doppelrolle RO60 aus hochwertigem Kunststoff, schwarz

Twin wheel castor for furniture RO60, made of high-quality plastic, black

Roulette à double roue pour meubles RO60 en plastique de haute qualité, noire

														1x			Code	EAN-Code
59	57		62	46	8	X	50							X			01 0079 01	...028522
59	57	X	62	46	8	X	50							X			01 0116 01	...417920



Möbel-Doppelrolle RO60 aus hochwertigem Kunststoff, mit Radfeststeller, schwarz

Twin wheel castor for furniture RO60, with brake, made of high-quality plastic, black

Roulette à double roue pour meubles RO60, avec blocage, en plastique de haute qualité, noire

														1x			Code	EAN-Code
59	57		62	46	8	X	50							X			01 0115 01	...034974
59	57	X	62	46	8	X	50							X			01 0117 01	...220131



Möbel-Doppelrolle RO39 ECO FRIENDLY aus hochwertigem Holz-Kunststoff-Gemisch

Twin wheel castor for furniture RO39 ECO FRIENDLY from high-quality wood-plastic composite

Roulette à double roue pour meubles RO39 ECO FRIENDLY en composite bois-plastique

															1x			Code	EAN-Code
37	50		40	30	8	X	30								X			01 0203 01	4001073 ...
																			...009286



Möbel-Doppelrolle RO39 ECO FRIENDLY aus hochwertigem Holz-Kunststoff-Gemisch, mit Radfeststeller

Twin wheel castor for furniture RO39 ECO FRIENDLY, with brake, from high-quality wood-plastic composite

Roulette à double roue pour meubles RO39 ECO FRIENDLY, avec blocage, en composite bois-plastique

															1x			Code	EAN-Code
37	50		40	30	8	X	30								X			01 0213 01	4001073 ...
																			...400748

Möb

elrollen

RO 73 / METRIS / RONDO

*Furniture castors
Roulettes pour meubles*

Möbe

Iggleiter

Gliders for furniture
Patins pour meubles



Möbelgleiter aus hochwertigem Kunststoff, schwarz
 Glider for furniture, made of high-quality plastic, black
 Patin pour meubles, en plastique de haute qualité, noir

Dimensions (mm)			Weight (kg)	Material & Properties										Quantity	Material	Code	EAN-Code	
44	14	25	100												1x	PE	16 0404 01	...053630
44	24	25	100														16 0405 01	...053647



Möbelgleiter aus hochwertigem Kunststoff, schwarz
 Glider for furniture, made of high-quality plastic, black
 Patin pour meubles, en plastique de haute qualité, noir

Dimensions (mm)			Weight (kg)	Material & Properties										Quantity	Material	Code	EAN-Code	
44	14	7	100												1x	PE	16 0406 01	...053654
44	24	7	100														16 0407 01	...053708



Möbelgleiter aus hochwertigem Kunststoff, zweiteilig, justierbar, schwarz
 Glider for furniture, made of high-quality plastic, two parts, adjustable, black
 Patin pour meubles en plastique de haute qualité, en deux pièces, ajustable, noir

Dimensions (mm)			Weight (kg)	Material & Properties										Quantity	Material	Code	EAN-Code	
50	55	23-35	35	26	4	35									1x	PE	01 0049 01	...328820

Befesti

gungen

Fixing elements

Fixations

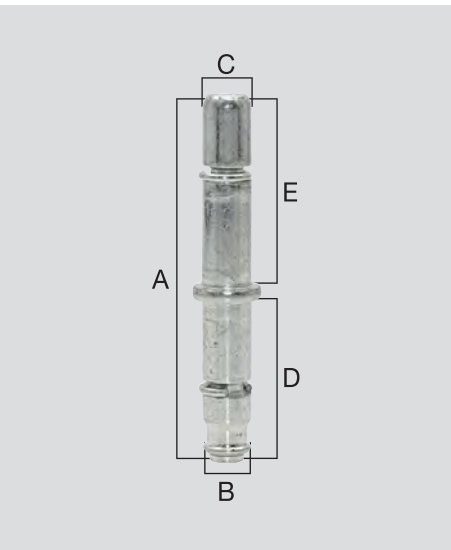

Steckstift verzinkt Ø 8 mm
Galvanised insert stem Ø 8mm
Tige zinguée Ø 8 mm



A	B	C	D	E			1x			Code	EAN-Code 4001073 ...
58	8	8	26	30				2		11 0097 99	...598414
58	8	8	26	30			X			11 0097 01	...030419

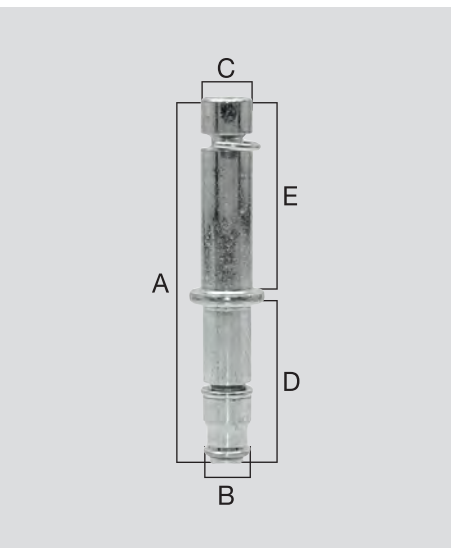

Reduzierstift verzinkt Ø 8,5 mm
Galvanised reducing stem Ø 8,5 mm
Tige à réduire zinguée Ø 8,5 mm



A	B	C	D	E			1x			Code	EAN-Code 4001073 ...
59	8	8,5	26	31				2		11 0092 99	...829204
59	8	8,5	26	31			X			11 0092 01	...029918

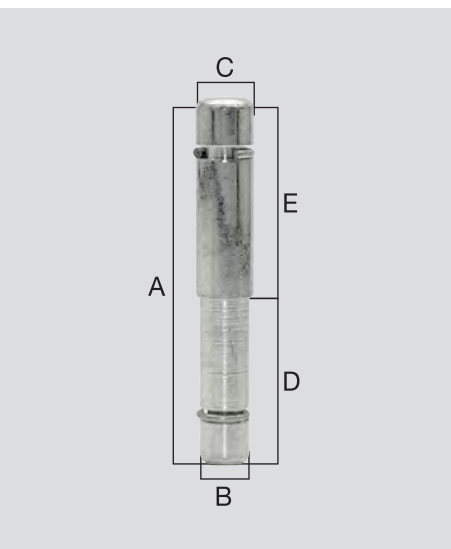

Reduzierstift verzinkt Ø 9 mm
Galvanised reducing stem Ø 9 mm
Tige à réduire zinguée Ø 9 mm



A	B	C	D	E			1x			Code	EAN-Code 4001073 ...
57	8	9	26	31				2		11 0093 99	...400427
57	8	9	26	31			X			11 0093 01	...030013

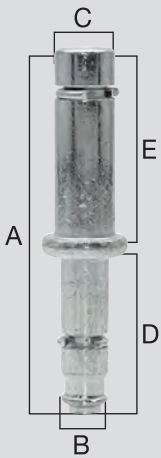

Reduzierstift verzinkt Ø 10 mm
Galvanised reducing stem, Ø 10 mm
Tige à réduire zinguée Ø 10 mm



A	B	C	D	E			1x			Code	EAN-Code 4001073 ...
60	8	10	26	30				2		11 0094 99	...202540
60	8	10	26	30			X			11 0094 01	...030112

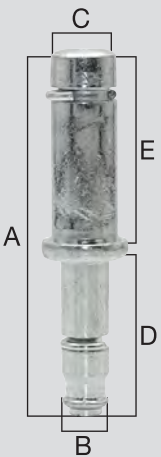

Reduzierstift verzinkt Ø 11 mm
Galvanised reducing stem, Ø 11 mm
Tige à réduire zinguée Ø 11 mm



A	B	C	D	E			1x			Code	EAN-Code 4001073 ...
60	8	11	26	30				2		11 0095 99	...602968
60	8	11	26	30			X			11 0095 01	...030211

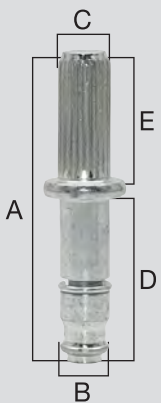

Riffelstift verzinkt Ø 8,4 mm
Galvanised grooved stem Ø 8,4 mm
Tige cannellée zinguée Ø 8,4 mm



A	B	C	D	E			1x			Code	EAN-Code 4001073 ...
49	8	8,4	26	20				2		11 0096 99	...602685
49	8	8,4	26	20			X			11 0096 01	...030310

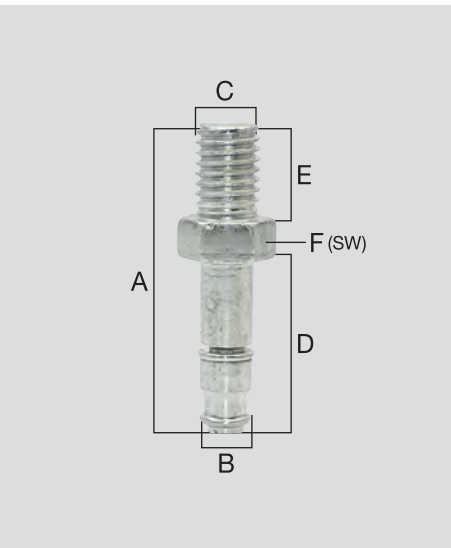

Gewindestift verzinkt M 10 x 14 mm / SW 13 mm

Galvanised threaded stem M 10 x 14 mm / SW 13 mm

Tige filetée zinguée M 10 x 14 mm / SW 13 mm



A	B	C	D	E	F		1x			Code	EAN-Code 4001073 ...
46	8	10	26	14	13			2		11 0089 99	...603071
46	8	10	26	14	13		X			11 0089 01	...029611

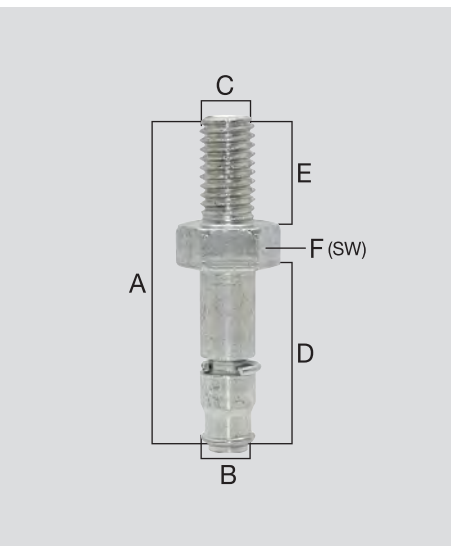

Gewindestift verzinkt M 8 x 15 mm / SW 13 mm

Galvanised threaded stem M 8 x 15 mm / SW 13 mm

Tige filetée zinguée M 8 x 15 mm / SW 13 mm



A	B	C	D	E	F		1x			Code	EAN-Code 4001073 ...
47	8	8	26	15	13			2		11 0090 99	...598711
47	8	8	26	15	13		X			11 0090 01	...029710

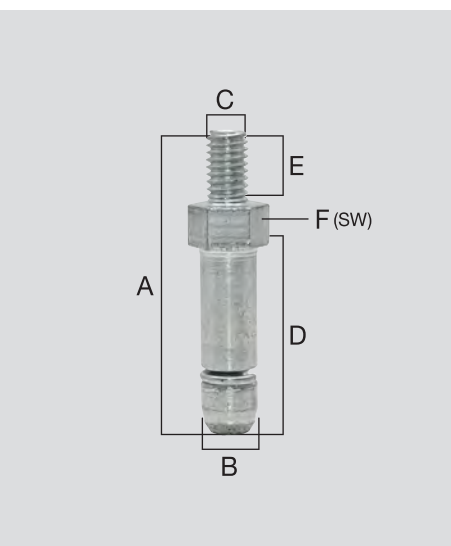

Gewindestift verzinkt M 6 x 8 mm / SW 10 mm

Galvanised threaded stem M 6 x 8 mm / SW 10 mm

Tige filetée zinguée M 6 x 8 mm / SW 10 mm



A	B	C	D	E	F		1x			Code	EAN-Code 4001073 ...
40	8	6	26	8	10			2		11 0091 99	...602883
40	8	6	26	8	10		X			11 0091 01	...029819

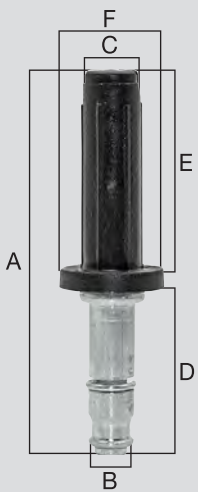

Teewagenstift verzinkt, mit Einschlaghülse Ø 10 mm
 Galvanised stem for tea-wagon, with press cap Ø 10 mm
 Tige zinguée pour table roulante, avec douille à battre Ø 10 mm



A	B	C	D	E	F		1x			Code	EAN-Code 4001073 ...
63	8	10	26	34	18			2		11 0080 99	...602876
63	8	10	26	34	18		X			11 0080 01	...028713



Stift verzinkt, mit Einschlaghülse Ø 13 mm
 Galvanised stem, with press cap Ø 13 mm
 Tige zinguée, avec douille à battre Ø 13 mm



A	B	C	D	E	F		1x			Code	EAN-Code 4001073 ...
58	8	13	26	27	18			2		11 0082 99	...602586
58	8	13	26	27	18		X			11 0082 01	...028911

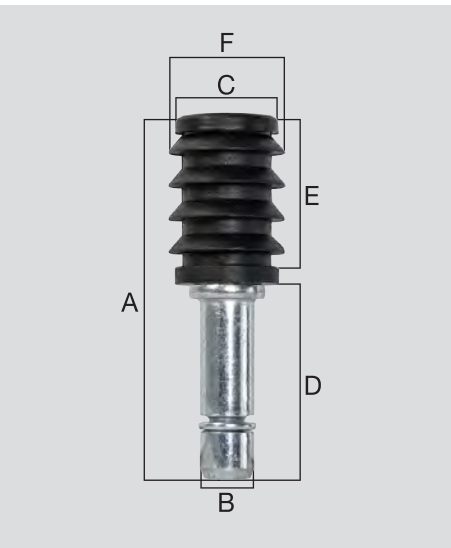

Stift verzinkt, mit Rundrohrhülse Ø 17 mm
Galvanised stem, with round cap Ø 17 mm
Tige zinguée, avec douille ronde Ø 17 mm



A	B	C	D	E	F		1x			Code	EAN-Code 4001073 ...
58	8	17	26	26	20			2		11 0083 99	...400403
58	8	17	26	26	20		X			11 0083 01	...029017

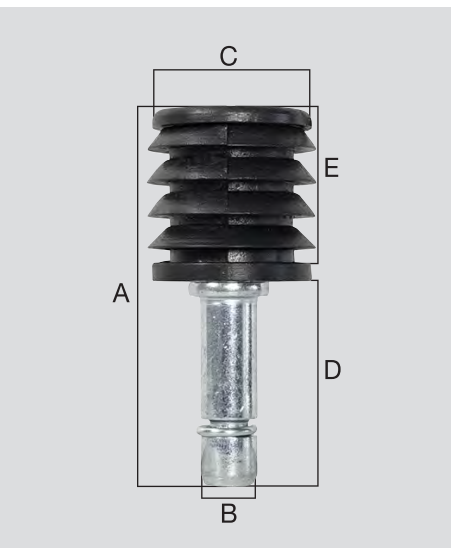

Stift verzinkt, mit Rundrohrhülse Ø 22 mm
Galvanised stem, with round cap Ø 22 mm
Tige zinguée, avec douille ronde Ø 22 mm



A	B	C	D	E			1x			Code	EAN-Code 4001073 ...
50	8	22	26	21				2		11 0099 99	...602791
50	8	22	26	21			X			11 0099 01	...030617

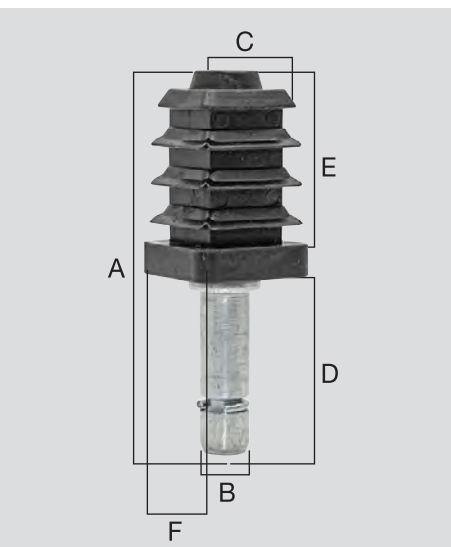

Stift verzinkt, mit Vierkanthülse 17 x 17 mm
Galvanised stem, with square cap 17 x 17 mm
Tige zinguée, avec douille carrée 17 x 17 mm



A	B	C	D	E	F		1x			Code	EAN-Code 4001073 ...
63	8	17	26	33	20			2		11 0084 99	...598612
63	8	17	26	33	20		X			11 0084 01	...029116

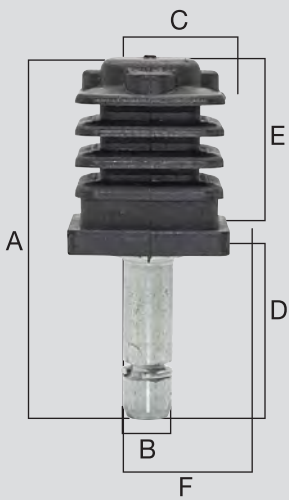

Stift verzinkt, mit Vierkanthülse 22 x 22 mm
Galvanised stem, with square cap 22 x 22 mm
Tige zinguée, avec douille carrée 22 x 22 mm



A	B	C	D	E	F		1x			Code	EAN-Code 4001073 ...
55	8	22	26	25	25			2		11 0085 99	...602777
55	8	22	26	25	25		X			11 0085 01	...029215



Stift verzinkt, mit Vierkanthülse 27 x 27 mm
Galvanised stem, with square cap 27 x 27 mm
Tige zinguée, avec douille carrée 27 x 27 mm



A	B	C	D	E	F		1x			Code	EAN-Code 4001073 ...
63	8	27	26	32	30			2		11 0086 99	...602593
63	8	27	26	32	30		X			11 0086 01	...029314

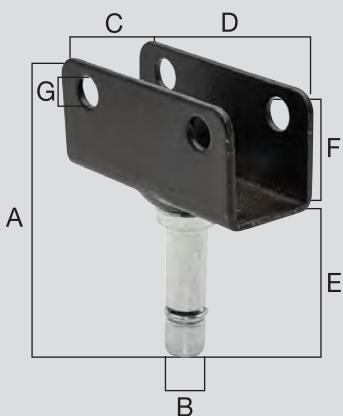

U-Profil verzinkt 16 mm, 19 mm
Galvanised U-Profile 16 mm, 19 mm
Profilé en U zingué, 16 mm, 19 mm



A	B	C	D	E	F	G	1x			Code	EAN-Code 4001073 ...
55	8	16/19	26	27	22	6		2		11 9188 99	...829259
55	8	16/19	26	27	22	6	X			11 9188 01	...431612

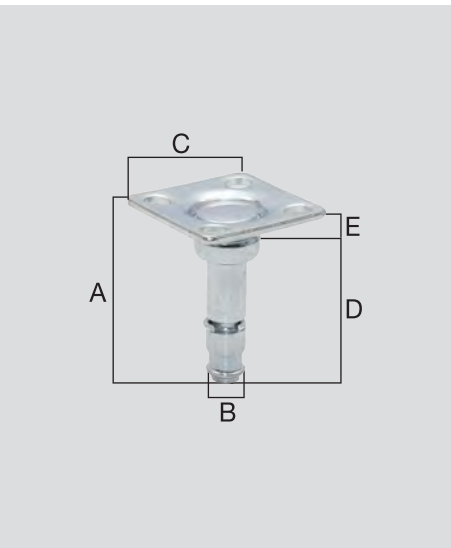

Anschraubplatte verzinkt
Galvanised screw-on plate
Platine à visser zinguée



A	B	C	D	E			1x		PE	Code	EAN-Code 4001073 ...
36	8	28	26	10	19	5		2		11 0087 99	...598513
36	8	28	26	10	19	5	X			11 0087 01	...029413

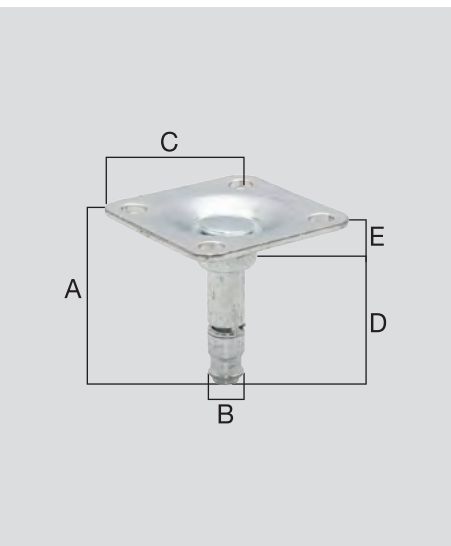

Anschraubplatte verzinkt
Galvanised screw-on plate
Platine à visser zinguée



A	B	C	D	E			1x		PE	Code	EAN-Code 4001073 ...
37	8	38	26	11	27	5		2		11 0088 99	...829358
37	8	38	26	11	27	5	X			11 0088 01	...029512

Anschraubplatte verzinkt
Galvanised screw-on plate
Platine à visser zinguée

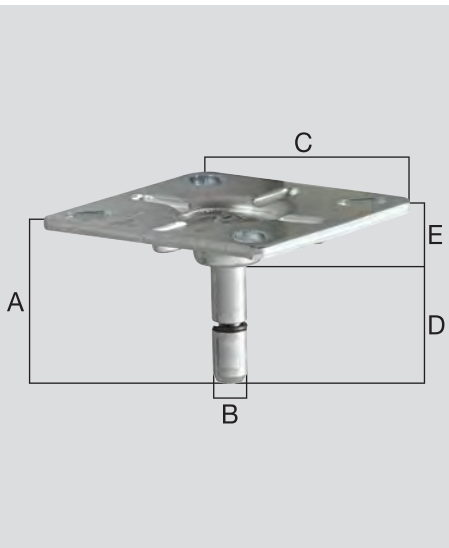

A	B	C	D	E			1x			Code	EAN-Code 4001073 ...
39	8	60	27	12	42	7x11	X			11 0388 01	... 354812

Drehstu

hlrollen

Castors for swivel chairs
Roulettes pour chaises pivotantes



Drehstuhl-Doppelrolle aus hochwertigem Kunststoff, mit Stift, intervallgebremst, schwarz

Twin wheel castor, for swivel-chairs, made of high-quality plastic, with stem, interval brake, black

Roulette à double roue pour chaises pivotantes, en plastique de haute qualité, avec tige, autobloquante, noire

													1x			Code	EAN-Code 4001073 ...
50	55	57	47	10		X	50						X			01 5001 01	...056518
50	55	57	47		11x20		50						X			01 5001 61	...056747
50	55	57	47		11x20		50							5		02 5001 61	...020731

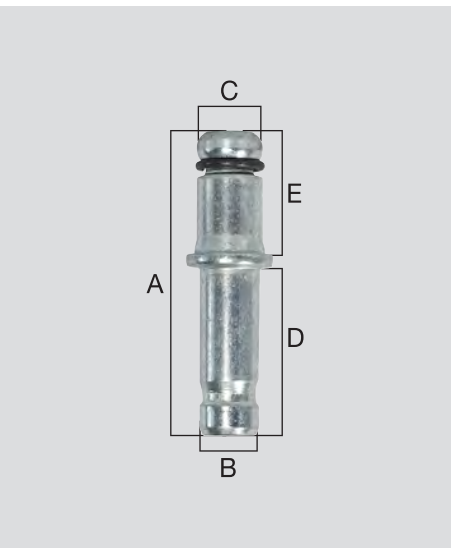

Steckstift verzinkt, für Drehstuhl-Doppelrollen,
10x20 mm / 10x29 mm

Galvanised reducing stem, for twin wheel castors for swivel
chairs, 10x20 mm / 10x29 mm

Tige à réduire zinguée, pour roulettes à double roue pour chaises
pivotantes, 10x20 mm / 10x29 mm



A	B	C	D	E			1x			Code	EAN-Code 4001073 ...
52	10	11	29	20			X			11 0061 01	...301311

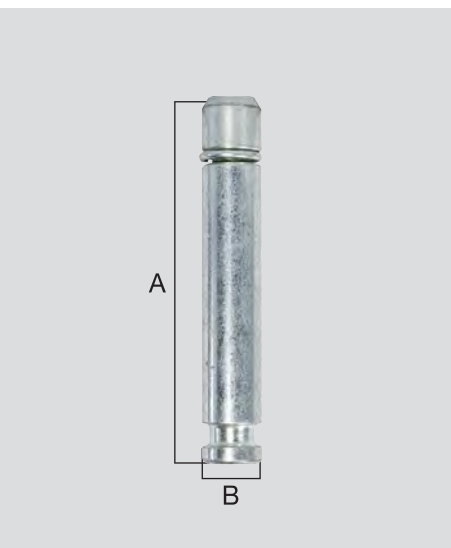

Steckstift verzinkt, für Drehstuhl-Doppelrollen, 10 x 60 mm

Galvanised stem for twin wheel castors for swivel chairs, 10 x
60 mm

Tige zinguée, pour roulettes à double roue pour chaises pivo-
tantes, 10 x 60 mm



A	B						1x			Code	EAN-Code 4001073 ...
60	10						X			11 0062 01	...027211

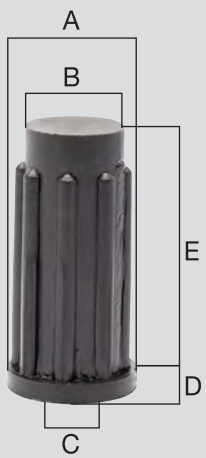

Hülse für Steckstift, 11 x 20 mm
 cap for insert stem, 11 x 20 mm
 douille pour tige, 11 x 20 mm



A	B	C	D	E			1x			Code	EAN-Code 4001073 ...
18	16	11	2,8	34					100	11 0039 01	...509373

Roll

er-Mini

Roller-Mini
Roller-Mini



reddot design award
honourable mention 2009

Roller-Mini Lenkrolle, Gehäuse: hochwertiger Kunststoff, schwarz, Rad: hart/soft

Roller-Mini swivel castor, casing: high-quality plastic, black, wheel: hard/soft

Roller-Mini roulette pivotante, support : plastique de haute qualité, noir, roue : dure/soft

15	13	soft	X	X	8	54	17	40	50	kg				1x		PE	Code	EAN-Code
15	13		X		8	54	17	40	50					X			01 7001 01	...041019
15	13	X	X		8	54	17	40	50					X			01 7070 01	...296716
15	13			X	8	54	17	40	50					X			01 7090 01	...353105



reddot design award
honourable mention 2009

Roller-Mini Lenkrolle, Gehäuse: hochwertiger Kunststoff, schwarz, Rad: hart/soft

Roller-Mini swivel castor, casing: high-quality plastic, black, wheel: hard/soft

Roller-Mini roulette pivotante, support : plastique de haute qualité, noir, roue: dure/soft

15	13	soft	X	X	8	54	11	40	50	kg				1x		PE	Code	EAN-Code
15	13		X		8	54	11	40	50					X			01 7002 01	...291117
15	13	X	X		8	54	11	40	50					X			01 7073 01	...269925



reddot design award
honourable mention 2009

Roller-Mini Lenkrolle, Gehäuse: hochwertiger Kunststoff, schwarz, Rad: hart/soft, Kugellager, Drehkranz

Roller-Mini swivel castor, casing: high-quality plastic, black, wheel: hard/soft, ball bearing, ball ring

Roller-Mini roulette pivotante, support : plastique de haute qualité, noir, roue: dure/soft, roul. à billes, couronne de pivot

15	13	soft	X	X	8	54	11	40	50	kg				1x		PE	Code	EAN-Code
15	13	X	X		8	54	11	40	50					X			01 7093 01	...396829
15	13		X		8	54	11	40	50					X			01 7094 01	...694406



reddot design award
honourable mention 2009

Roller-Mini Lenkrolle, Gehäuse: hochwertiger Kunststoff, schwarz, Rad: hart/soft

Roller-Mini swivel castor, casing: high-quality plastic, black, wheel: hard/soft

Roller-Mini roulette pivotante, support : plastique de haute qualité, noir, roue : dure/soft

Top View	Side View	soft	Wheel	Height	Width	Depth	Weight	1x	Cloud	PE	Code	EAN-Code
27	13		X	14	64	17	50	X			01 7005 01	...307719
27	13	X	X	14	64	17	50	X			01 7081 01	...319019



reddot design award
honourable mention 2009

Roller-Mini Lenkrolle **STOPP leicht**, mit Bremseffekt bei leichter Belastung, Gehäuse: hochwertiger Kunststoff, schwarz, Rad: hart/soft

Roller-Mini swivel castor **STOPP light**, brake effect with light load, casing: high-quality plastic, black, wheel: hard/soft

Roller-Mini roulette pivotante **STOPP légère**, avec un effet de blocage avec charge légère, support : plastique de haute qualité, noir, roue : dure/soft

Top View	Side View	soft	Wheel	Height	Width	Depth	Weight	1x	Cloud	PE	Code	EAN-Code
15	13		X	8	54	17	40	X			01 7004 01	...041033
15	13	X	X	8	54	17	40	X			01 7006 01	...041057
27	13		X	14	64	17	50	X			01 7009 01	...319040
27	13	X	X	14	64	17	50	X			01 7080 01	...319026



reddot design award
honourable mention 2009

Roller-Mini Lenkrolle **STOPP schwer**, mit Bremseffekt bei schwerer Belastung, Gehäuse: hochwertiger Kunststoff, schwarz, Rad: hart/soft

Roller-Mini swivel castor **STOPP heavy**, brake effect with heavy load, casing: high-quality plastic, black, wheel: hard/soft

Roller-Mini roulette pivotante **STOPP lourde**, avec un effet de blocage avec charge lourde, support : plastique de haute qualité, noir, roue : dure/soft

Top View	Side View	soft	Wheel	Height	Width	Depth	Weight	1x	Cloud	PE	Code	EAN-Code
15	13			X	8	54	17	40	50	X	01 7091 01	...155341
15	13		X		8	54	17	40	50	X	01 7007 01	...041101
15	13	X	X		8	54	17	40	50	X	01 7008 01	...041118
27	13		X		14	64	17	50	50	X	01 7014 01	...319101
27	13	X	X		14	64	17	50	50	X	01 7083 01	...319033



reddot design award
honourable mention 2009

Roller-Mini Bockrolle, Gehäuse: hochwertiger Kunststoff, schwarz, Rad: hart/soft

Roller-Mini fixed castor, casing: high-quality plastic, black, wheel: hard/soft

Roller-Mini roulette fixe, support : plastique de haute qualité, noir, roue : dure/soft

Top View	Side View	soft	Wheel	Wheel Type	Wheel Diameter	Wheel Width	Mounting Hole	Mounting Hole Spacing	Weight	Quantity	Material	Code	EAN-Code	
					8	54		17	40	50	1x		01 7011 01	...041415
15	13		X		8	54		17	40	50			01 7011 04	...041231
15	13	X	X		8	54		17	40	50		4	01 7071 01	...296815



reddot design award
honourable mention 2009

Roller-Mini Bockrolle, Gehäuse: hochwertiger Kunststoff, schwarz, Rad: hart/soft

Roller-Mini fixed castor, casing: high-quality plastic, black, wheel: hard/soft

Roller-Mini roulette fixe, support : plastique de haute qualité, noir, roue : dure/soft

Top View	Side View	soft	Wheel	Wheel Type	Wheel Diameter	Wheel Width	Mounting Hole	Mounting Hole Spacing	Weight	Quantity	Material	Code	EAN-Code	
					14	54		17	40	50	1x		01 7012 01	...041811
27	13		X		14	54		17	40	50			01 7072 01	...270013
27	13	X	X		14	54		17	40	50		X	01 7072 01	...270013



reddot design award
honourable mention 2009

Roller-Mini Bockrolle, Gehäuse: hochwertiger Kunststoff, schwarz, Rad: hart/soft

Roller-Mini fixed castor, casing: high-quality plastic, black, wheel: hard/soft

Roller-Mini roulette fixe, support : plastique de haute qualité, noir, roue : dure/soft

Top View	Side View	soft	Wheel	Wheel Type	Wheel Diameter	Wheel Width	Mounting Hole	Mounting Hole Spacing	Weight	Quantity	Material	Code	EAN-Code	
					14	64		17	50	50	1x		01 7015 01	...307917
27	13		X		14	64		17	50	50			01 7082 01	...319118
27	13	X	X		14	64		17	50	50		X	01 7082 01	...319118



Roller-Mini MAX Lenkrolle, Rollentopf: hochwertiger Kunststoff, schwarz, Rad: hart/soft

Roller-Mini MAX swivel castor, casing: high-quality plastic, black, wheel: hard/soft

Roller-Mini MAX, boitier à roulette: plastique de haute qualité, noir, roue: dure/soft

		soft											1x			Code	EAN-Code
27	13	X	X	21	103	19	85	85	6	50			X			01 7085 01	...319149
27	13		X	21	103	19	85	85	6	50			X			01 7086 01	...041354



Tischauszugsrolle zur Führung von Tischplatten/-beinen, Gehäuse: hochwertiger Kunststoff, schwarz

Guide castor for extendable tables for the guiding of table tops/-legs, casing: high-quality plastic, black

Roulette pour table à rallonge pour la guidance des surfaces / pieds de table, support : plastique de haute qualité, noir

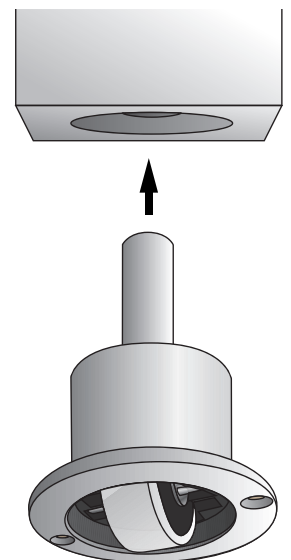
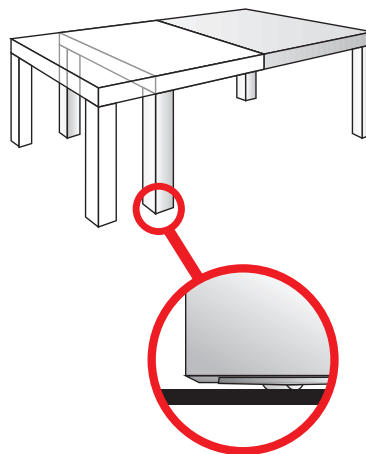

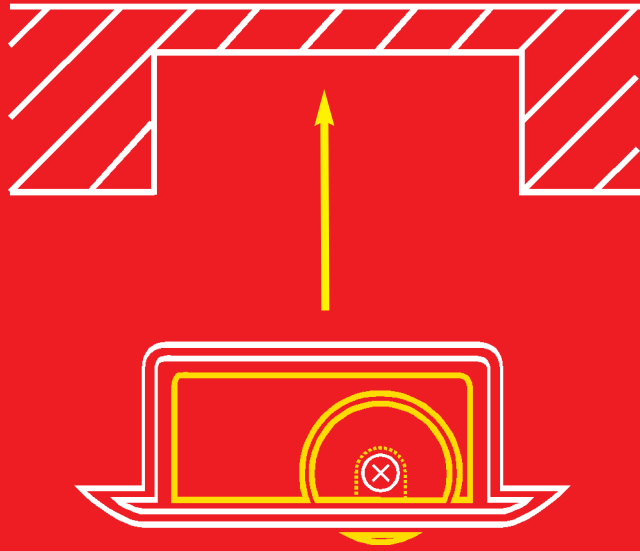

lowest



Roller-Mini sind die intelligente Alternative zu klassischen Möbelrollen. Ihre Stärke ist die Unsichtbarkeit: In der Bodenplatte eines Möbelstückes versenkt, lassen die **Roller-Mini** es, von außen nicht sichtbar, in geringem Abstand zum Boden "schweben". Damit ermöglichen alle **Roller-Mini** dem Design des Möbels ungestörten Freiraum.

Roller-Mini are the intelligent alternative to the classical furniture castors. Their strongest point is their invisibility: just placed in the bottom plate of the furniture, **Roller-Mini** are not visible and make it "hover" with a small distance to the floor. Nearly invisible, the **Roller-Mini** do not disturb the liberty of a furniture's design.

Les **Roller-Mini** sont l'alternative intelligente pour les roulettes de meubles classiques. La caractéristique la plus importante est son invisibilité: les **Roller-Mini** sont enfoncés dans la plaque du fond du meuble et le fond planer avec une petite distance entre le meuble et le sol. Etant invisibles, les **Roller-Mini** ne dérangent pas la liberté du design d'un meuble.

high

Roller-Mini BSR, Bohrsenkrollen, sind die intelligente Alternative zu Schubladenführungen. Sie sind als Lauf-, Dreh-, und Führungsrollen unschlagbar, weil sie ein Minimum an Einbauhöhe und ein Maximum an Raum für das zu führende Teil zulassen.

Roller-Mini BSR, drilled flush castors, are the intelligent alternative to drawer guidances. They are unbeatable as sheaves, rotary and guiding castors, because they only need very little height for installation and permit a lot of space for the piece which has to be lead.

Les **Roller-Mini BSR**, les roulettes encastrables, sont l'alternative intelligente pour les glissières de tiroirs. Elles sont imbattables comme roulette de guide et pivot, avec une profondeur minimale pour l'encastrer degageant un maximum d'espace pour le guidage d'objet.

Einfachste Montage - größte Gestaltungs- und Bewegungsfreiheit!

Simplest assembly - largest freedom of design and movement!

Montage simple - mobilité et liberté de design maximale !



Roller-Mini BSR Bohrsenkrolle mit Bund, Gehäuse: hochwertiger Kunststoff, schwarz, Rad: hart/soft

Roller-Mini BSR retractable castor with collar, casing: high-quality plastic, black, wheel: hard/soft

Roller-Mini BSR roulette encastrable avec ceinture, support : plastique de haute qualité, noir, roue : dure/soft

15	13	soft	X	2	32	17	25	50					1x		PE	Code	EAN-Code
15	13		X	2	32	17	25	50					X			01 7054 01	...294217
15	13	X	X	2	32	17	25	50					X			01 7057 01	...421316



Roller-Mini BSR Bohrsenkrolle mit Bund, Gehäuse: hochwertiger Kunststoff, schwarz, Rad: hart/soft

Roller-Mini BSR retractable castor with collar, casing: high-quality plastic, black, wheel: hard/soft

Roller-Mini BSR roulette encastrable avec ceinture, support : plastique de haute qualité, noir, roue : dure/soft

15	13	soft	X		5	32	14	25	50				1x		PE	Code	EAN-Code
15	13		X		5	32	14	25	50				X			01 7055 01	...384819
15	13	X	X		5	32	14	25	50				X			01 7058 01	...421415
15	13			X	5	32	14	25	50				X			01 7017 01	...350838

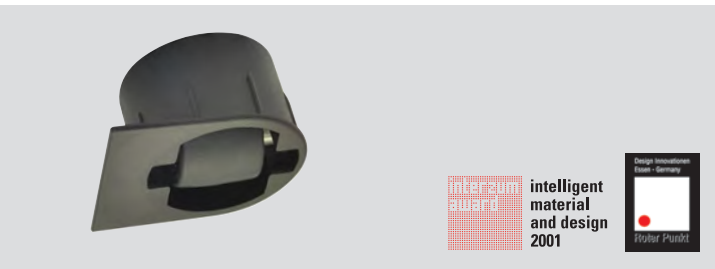

Roller-Mini BSR Bohrsenkrolle mit Bund, Gehäuse: hochwertiger Kunststoff, schwarz, Rad: extrem soft

Roller-Mini BSR retractable castor with collar, casing: high-quality plastic, black, wheel: extreme soft

Roller-Mini BSR roulette encastrable avec ceinture, support : plastique de haute qualité, noir, roue : extrême soft

15	13	soft	X	X	2	32	17	25	50				1x		PE	Code	EAN-Code
15	13	X	X		2	32	17	25	50				X			01 7066 01	...421507
15	13	X	X		5	32	14	25	50				X			01 7063 01	...421439



Roller-Mini BSR Bohrsenkrolle ohne Bund, Gehäuse: hochwertiger Kunststoff, schwarz, Rad: hart/soft

Roller-Mini BSR retractable castor without collar, casing: high-quality plastic, black, wheel: hard/soft

Roller-Mini BSR roulette encastrable sans ceinture, support : plastique de haute qualité, noir, roue : dure/soft

15	13	soft	X	2	26	17	25	50					1x		PE	Code	EAN-Code 4001073 ...
15	13		X	2	26	17	25	50					X			01 7050 01	...294149
15	13	X	X	2	26	17	25	50					X			01 7049 01	...294132



Roller-Mini BSR Bohrsenkrolle ohne Bund, Gehäuse: hochwertiger Kunststoff, schwarz, Rad: hart/soft

Roller-Mini BSR retractable castor without collar, casing: high-quality plastic, black, wheel: hard/soft

Roller-Mini BSR roulette encastrable sans ceinture, support : plastique de haute qualité, noir, roue : dure/soft

15	13	soft	X	X	5	26	13	25	50				1x		PE	Code	EAN-Code 4001073 ...
15	13			X	5	26	13	25	50				X			01 7016 01	...154146
15	13		X		5	26	13	25	50				X			01 7053 01	...294200
15	13	X	X		5	26	13	25	50				X			01 7052 01	...294156



Roller-Mini BSR Bohrsenkrolle **STOPP leicht**, ohne Bund, mit Bremseffekt bei leichter Belastung, Gehäuse: schwarz, Rad: hart/soft

Roller-Mini BSR retractable castor **STOPP light**, without collar, brake effect with light load, casing: black, wheel: hard/soft

Roller-Mini BSR roulette encastrable **STOPP légère**, sans ceinture, avec un effet de blocage avec charge légère, support : noir, roue : dur/soft

15	13	soft	X	X	5	29	17	25	50				1x		PE	Code	EAN-Code 4001073 ...
15	13			X	5	29	17	25	50				X			01 7069 01	...225426
15	13		X		5	29	17	25	50				X			01 7047 01	...421347
15	13	X	X		5	29	17	25	50				X			01 7045 01	...421408



Roller-Mini BSR Bohrsenkrolle **STOPP schwer**, ohne Bund, mit Bremseffekt bei schwerer Belastung, Gehäuse: hochwertiger Kunststoff, schwarz, Rad: hart/soft

Roller-Mini BSR retractable castor **STOPP heavy**, high-quality plastic, without collar, brake effect with heavy load, casing: black, wheel: hard/soft

Roller-Mini BSR roulette encastrable **STOPP lourde**, plastique de haute qualité, avec ceinture, avec un effet de blocage sans charge lourde, support : noir, roue : dure/soft

15	13	soft			6	29	17	25	50				1x		PE	Code	EAN-Code 4001073 ...
15	13			X	6	29	17	25	50				X			01 7043 01	...218251
15	13		X		6	29	17	25	50				X			01 7046 01	...421354
15	13	X	X		6	29	17	25	50				X			01 7044 01	...421422



Roller-Mini BSR Bohrsenkrolle **STOPP leicht**, mit Bund, mit Bremseffekt bei leichter Belastung, Gehäuse: schwarz, Rad: hart/soft

Roller-Mini BSR retractable castor **STOPP light**, with collar, brake effect with light load, casing: black, wheel: hard/soft

Roller-Mini BSR roulette encastrable **STOPP légère**, avec ceinture, avec un effet de blocage avec charge légère, support : noir, roue : dur/soft

15	13	soft			6	32	17	25	50				1x		PE	Code	EAN-Code 4001073 ...
15	13		X	6	32	17	25	50					X			01 7078 01	...001716
15	13	X	X	6	32	17	25	50					X			01 7076 01	...001235



Roller-Mini BSR Bohrsenkrolle **STOPP schwer**, mit Bund, mit Bremseffekt bei schwerer Belastung, Gehäuse: hochwertiger Kunststoff, schwarz, Rad: hart/soft

Roller-Mini BSR retractable castor **STOPP heavy**, high-quality plastic, with collar, brake effect with heavy load, casing: black, wheel: hard/soft

Roller-Mini BSR roulette encastrable **STOPP lourde**, plastique de haute qualité, avec ceinture, avec un effet de blocage avec charge lourde, support : noir, roue : dure/soft

15	13	soft			6	32	17	25	50				1x		PE	Code	EAN-Code 4001073 ...
15	13			X	6	32	17	25	50				X			01 7018 01	...153040
15	13		X		6	32	17	25	50				X			01 7079 01	...002317
15	13	X	X		6	32	17	25	50				X			01 7077 01	...001518

A Apparaterolle

Kräftige, sehr leichtgängige Rolle, z. B. für moderne Wohn- und Küchenmöbel, Werkstatt- und Objekteinrichtungen, Krankenmöbel, Betten, technische Geräte, Haushaltsgeräte und Apparate

B Befestigung

Verbindung von Rolle zu Möbel: Möbelrollen, Designrollen sowie Apparate- und Transportgeräterollen mit Rückenloch können durch das Wagner-Norm System mit Befestigungselementen für jede gewünschte Anwendung kombiniert werden

Bettkastenrolle

Seitlich anschraubbar, z. B. für Bettkästen, Bodenauszüge, Podeste und Schubladen

Bockrolle

Rolle mit starrer Gabel für spurstabilen, geraden Lauf

D Designrolle

Rolle mit ausgezeichnetem Design, in ungewöhnlicher Optik, z. B. Designpreisträger RO73 (Design: Roland Wagner), perfektes gestalterisches Element für zeitgemäßes Möbeldesign

Designrolle „STOPP schwer“

Rolle mit eingebautem Stopper; bei großer Belastung wird eine blockierende Wirkung erzeugt, die ein Rollen des Möbelstückes verhindert; höchster Sicherheitsfaktor bei der Anwendung, z. B. Sitzhocker

Designrolle „STOPP leicht“

Rolle mit eingebautem Stopper; bereits bei geringer Belastung wird eine blockierende Wirkung erzeugt, die ein Wegrollen des Möbelstückes verhindert; hoher Sicherheitsfaktor bei der Anwendung, z. B. Kindermöbel

Doppelrolle

Vorteil: hohe Tragkraft bei niedriger Bauhöhe; wegen der geringen Flächenpressung zwischen Rad und Boden ist die Rolle auch bei hoher Belastung leicht schwenkbar

L Lauffläche

Entscheidend für optimale Laufeigenschaften von Rollen u. Rädern. Es gilt die Regel: harter Boden – softe Lauffläche, weicher Boden – harte Lauffläche

Lenkrolle

Rolle mit schwenkbarer Gabel, manövrierbar in alle Richtungen

M Möbelgleiter

Für Bodenbeläge, bei denen der Einsatz von Rollen nicht die ideale Lösung darstellt, z. B. dicke Teppiche

Möbelrolle

Klassische Doppel- oder Kugelrollen, deren Einsatz zumeist im Wohnbereich erfolgen. Sie werden unter Wohn- und Büromöbeln, aber auch unter kleineren Haushaltsgeräten, wie z.B. Staubsaugern, angebracht

P Polyamid (PA)

Hochwertiger Kunststoff, der sich durch hohe mechanische Festigkeit, große Zähigkeit, Beständigkeit gegen organische Lösungsmittel und gute Lagereigenschaft auszeichnet

Polyurethan (PUR)

Thermoplastischer Kunststoff mit hoher Chemikalienbeständigkeit und Druckfestigkeit. Räder mit PUR-Laufbelag sind bodenschonend, besonders geräuscharm, stoßdämpfend, lauffeicht und hoch belastbar

R Radfeststeller

Bremsvorrichtung zum Blockieren des Radlaufs

Rollenlager

Robuste, hoch belastbare Lagerung, stoßunempfindlich, geringer Rollwiderstand, niedrige Einbauhöhe

S Schwerlastrolle

Extrem hoch belastbare Rolle, z. B. für industrielle Anwendungen

Glossar

E Elastik-Gummi

Hochwertiger Gummi für hohe Elastizität und hohe Belastbarkeit; extrem abriebfest; garantiert ausgezeichneten Fahrkomfort und sehr ruhigen Lauf

F Fadenschutz

Nicht mitdrehende Stahlblechkappe; umschließt die Radlagerung beidseitig und verhindert das Eindringen von Schmutz

G Gehäuse

Fasst das Rad der Rolle; Gehäuse hochwertiger Rollen werden aus soliden Industriestahl-Komponenten oder massivem Gusseisen gefertigt und für maximalen Korrosionsschutz zusätzlich verzinkt, verchromt oder pulverbeschichtet

Gleitlager

Stoßunempfindliche, weitgehend wartungsfreie und besonders günstige Lagerung

I Intervallbremsung

Integrierte Sicherheits-Federbremse; sobald die Rolle nicht belastet ist, bremst sie automatisch und verhindert das Wegrollen z. B. von Stühlen, Trittpodesten und Kindermöbeln

K Kugellager

Lagerung für höchste Belastungen; besonders langlebig, sehr stabil, exzellente Laufeigenschaften auch bei Dauereinsatz

Kunststoff

Hochwertiger Kunststoff gewährleistet Langlebigkeit, hohe Laugen- und Säurenresistenz, Form- und Farbstabilität

S Softlaufräder

Räder mit elastischer, weicher Lauffläche. Sie verhindern z.B. Kratzer und Streifen auf empfindlichen Böden wie Parkett, Laminat, Marmor und Fliesen. Zudem garantieren Sie einen leisen, geräuscharmen Lauf der Rolle

T Thermoplastischer Gummi (TPR)

Radgummierung für hohen Fahrkomfort und geräuscharmen Lauf; als „Ultrasoft“-Lauffläche geeignet für den Einsatz auf allen empfindlichen Bodenoberflächen wie Parkett, Laminat, Diele oder Fliese

Totalfeststeller

Bremsvorrichtung zur gleichzeitigen Blockierung der Schwenkung und des Radlaufs

Tragkraft

Zulässige Maximalbelastung von Rad oder Rolle auf glatter, ebener Fahrbahn. Die benötigte Tragkraft einer Rolle ist einfach zu berechnen: Eigengewicht des Möbels oder Gerätes + Zuladung : 3.

Warum durch drei geteilt wird? Bei unebenem Boden besteht die Möglichkeit, dass nur drei der vier Räder Bodenkontakt haben und dadurch die gesamte Last tragen müssen

Transportgeräterolle

Äußerst robuste, leichtgängige Rolle mit hoher Tragkraft, z. B. für Transportwagen, Werkstatt- und Objekteinrichtungen, technische Geräte

Z Zinkdruckguss

Präzisionsguss anspruchsvoller Formen, mit hoher mechanischer Festigkeit und idealen Voraussetzungen für besonders haltbare Oberflächenveredelung

B Ball bearing

Applied for maximal load capacity, especially durable, very stable, excellent rolling characteristics even when continuously in use

Bed frame castor

Attachable also to the side, i. e. for bed frames, extractable devices, pedestals and drawers

Brake

Braking device to block the wheel from rolling

C Casing

The casing for the high quality castor is made of solid industrial steel components or massive cast iron and additionally coated for corrosion protection in either zinc, chrome or powder

D Design castor

Award winning castor design with unusual optical appearance, i. e. Design Award RO 73, (Design: Roland Wagner). The perfect creative element for modern furniture design

Design castor „STOPP heavy“

Castor with inserted stopper. During large load a blocking effect is generated, which prevents a rolling of the furniture. High safety factor with application, for instance: seat stool

Design castor „STOPP light“

Castor with inserted stopper. Already during small load a blocking effect is generated and makes rolling the furniture more difficult. High safety factor with application, for instance: child furniture

Die cast zinc

Precision press exact moulding with high mechanical solidity and an ideal requirement for exceptional lasting surface refining

H Heavy-duty castor

Extremely high load capacity, i. e. for industrial use

High-quality plastic

Castors and wheels made of high value duroplastic and thermoplastic allowing for long term use, alkaline and acid resistant, maintains form and colour

I Interval brake

Integrated safety brake, brakes when not loaded and prevents rolling, e. g. chairs, step stools and children's furniture

L Load capacity

Maximal durability of a wheel or castor on a smooth and even surface. The required load capacity of a castor is easily calculated: weight of the furniture or appliance, plus the load divided by 3. Why divided by three? It is possible, due to uneven surfaces, that only three wheels are actually touching the ground, leaving the entire load capacity to be supported by only three wheels

P Plain bearing

A shock resistant, basically maintenance free and low priced bearing

Polyamid (PA)

Thermoplastic, noted for high mechanical strength, resistant to organic solvents. Good bearing characteristics

Polyurethan (PUR)

Thermoplastic plastic with high chemical resistance and compressive strength. Wheels with a PUR tread are particularly quiet, shock absorbent, smoothly running and highly loadable

R Roller bearing

Robust, heavy load capacity bearing, shock resistant, minimal roll resistance, low mounting level

Glossary

E Elastic rubber

High-quality rubber for high elasticity and high load capacity; extremely abrasion-resistant; guarantees excellent moving comfort and very quiet running characteristics

Equipment castor

Solid, smooth rolling castor, i. e. for modern living room and kitchen furniture, workshop and business furnishings, hospital furniture, beds, technical appliances, household appliances and equipment

F Fixed castor

Castor with fixed fork for straight stable rolling

Fixing element

Attaching castor to furniture: furniture castors as well as equipment and transport castors with a back hole fixing can be combined as desired for use with the proper fixing elements

Furniture gliders

For floor surfaces whereby the use of a castor is not the most appropriate solution, i. e. thick carpets and uneven surfaces

Furniture castors

Classic twin wheel castors or spherical castors are described as furniture castors, which are mainly used in living areas. They are fitted under lounge furniture and office furniture as well as under small household appliances like vacuum cleaners for example

S Soft running wheels

Soft running wheels are wheels with a resilient, soft, running surface. They prevent e.g., scratches and streaking on sensitive floors like parquet, laminate, marble and tiles. Moreover, they guarantee that the castor runs smoothly and quietly

Surface

Choosing your surface is the decisive factor for optimal rolling characteristics when choosing castors or wheels. The simple rule applies: hard floor – soft castors, soft floor – hard castors

Swivel castor

castor with swivel fork, manoeuvrable in all directions

T Thread guard

Non rotating steel cap; encloses the wheel bearing, therefore prevents and protects against dirt

Total brake

Brake device for simultaneous blocking of swivelling and rolling of the wheel

Transport equipment castor

Extremely robust, easy rolling castors with heavy load capacity, i. e. for transport equipment, living room and kitchen furniture, workshop and business furnishings, technical appliances and apparatuses

Twin wheel castor

Advantage: high load capacity for low construction. Due to the minimal surface pressure between the castor and the floor, the castor will easily roll, even with a heavy load

B Blocage

Frein permettant de bloquer la roue

Blocage total

Dispositif de blocage simultané de la roue et du pivotement

C Capacité de charge

Charge maximum admissible par roue ou roulette sur une surface plane. La charge nécessaire est facilement calculable: poids du meuble ou appareil en charge: par 3. Pourquoi par 3? Par sol inégal il peut arriver qu'une roue ne soit pas au contact du sol

Caoutchouc élastique

Caoutchouc de haute qualité pour haute élasticité et haute capacité de charge ; extrêmement résistant à l'usure ; excellent confort de conduite et propriétés de roulement très silencieuses garantis

F Fixations

Liens entre roulettes et meubles : roulettes d'ameublement, d'appareils et de transport, roulettes design avec logement standardisé peuvent recevoir avec le Wagner Norm System la fixation convenant à chaque support

Frein autobloquante

Frein à ressort de sécurité intégré ; dès que la roulette n'est pas chargée, il freine automatiquement et empêche le meuble, la chaise ou la table de se déplacer

Roulette pour meuble

Les roulettes pour meuble désignent les roulettes sphériques et les roulettes doubles classiques qui sont principalement utilisées dans le domaine privé. Elles sont placées sous des meubles de bureau et d'habitation mais aussi sous de petits appareils ménagers comme p. ex. les aspirateurs

Roulette d'appareils

Roulette robuste, mobile et souple, idéale pour la réalisation de mobilier, meubles de cuisines, de tables de travail, de chariots d'hôpitaux, de lits, d'installations techniques et d'appareils domestiques

Roulette de caissons

Se fixe latéralement par vis sur caissons de lit, boîtes de rangement et tiroirs

Roulette design

Roulette design avec forme particulière visuellement agréable comme p. ex. la roulette RO73 (Design: Roland Wagner). Un accessoire parfait idéal pour les meubles design contemporains

Roulette design „STOPP légère“

Roulette avec frein intégré. Une charge légère entraîne un blocage immédiat ce qui rend difficile le déplacement du meuble. Un facteur élevé de sécurité pour l'équipement comme p. ex. le mobilier pour enfants

Roulette design „STOPP lourde“

Roulette avec frein intégré. Une charge lourde entraîne un blocage immédiat ce qui rend difficile le déplacement du meuble. Un facteur élevé de sécurité pour l'équipement comme p. ex. des tabourets

Roulette double

Avantage: charge élevée avec faible hauteur. Grâce à la faible surface de contact entre sol et roulette, cette roulette pivote facilement même par lourde charge

Glossaire

P Palier lisse

Insensible aux chocs, quasi sans entretien et bon marché

Palier à rouleaux

Roulement robuste pour charges lourdes, résistant aux chocs, roulage facile, réduction de l' hauteur d'implantation

Pare fils

Coupelles en acier fermant latéralement les roulements des roues et les protégeant contre toutes introductions de saletés

Patin pour meubles

Pour revêtements de sol ou l'utilisation de roulettes n'est pas la solution idéale comme p. ex. un tapis épais ou une surface inégale

Plastique de haute qualité

Matière synthétique de haute qualité garantissant une longue durée de vie, une résistance à la corrosion, à la déformation et à la décoloration

Polyamide (PA)

Matière synthétique de haute valeur à forte résistance mécanique, anti-corrosive et de longue durée de vie

Polyuréthane (PUR)

Polymère thermoplastique avec une haute résistance chimique et une résistance à la compression. Les roues avec un revêtement en PUR ménagent les sols en plus d'être particulièrement silencieuses, d'absorber les chocs, d'avoir un fonctionnement doux et de supporter de charges lourdes

R Roulement à billes

Roulement pour des charges très lourdes et utilisation intensive, très stable et souple à longue durée de vie

Roulette fixe

Roulette rigide pour un déplacement rectiligne

Roulette pour poids lourds

Utilisation avec des charges extrêmement lourdes p. ex. pour l'usage au milieu industriel

Roulette pivotante

Roue montée sur châssis pivotant permettant un déplacement dans toutes les directions

Roulette de transport

Roulette très robuste et à roulage facile avec une haute capacité de charge pour manutention, mobilier de cuisine ou d'atelier, appareils et outils

Roues soft

Les roues soft sont des roues avec une surface souple et élastique. Elles empêchent la présence d'éraflures et de rayures sur les sols sensibles tels que le parquet, le laminé, le marbre et les carrelages. En outre, elles garantissent un mouvement de la roulette doux et silencieux.

S Support de roulette

Châssis pour des roulettes de haute qualité usinés à partir de tôle d'acier massive avec protection anti-corrosion zinguée, chromée ou revêtement par poudre

Surface de roulement

Décision importante pour obtenir les qualités optimale de roulage pour roues et roulettes. La règle est simple: sol dur – roulette souple, sol souple – roulette dure

Z Zinc coulé sous pression

Métal pour des formes de précision avec de grandes aptitudes mécaniques et idéal pour une affinage de sa surface particulièrement résistante

Desig

nrollen

*Design castors
Roulettes design*



Design-Lenkrolle mit Anschraubplatte, Gehäuse: Industriestahl, pulverbeschichtet, Rad: schwarz/silber-alu, Lauffläche: soft

Design swivel castor with screw-on plate, casing: industrial steel, powder-coated, wheel: black, aluminium-coloured, tread: soft

Roulette design pivotante avec platine à visser, support : acier industriel revêtu par poudre, roue : noire, couleur aluminium, surface : soft

														1x			Code	EAN-Code 4001073 ...
50	19	X	X	63	15	42x42	32	4	50					X			03 1353 01	...006247
75	23	X	X	96	27	60x60	44	6x8	50					X			03 1383 01	...006346



Design-Lenkrolle mit Anschraubplatte und Feststeller, Gehäuse: Industriestahl, pulverbesch., Rad: schwarz/silber-alu, Lauffl.: soft

Design swivel castor with screw-on plate and brake, casing: industrial steel, powder-coated, wheel: black, aluminium-coloured, tread: soft

Roulette design pivotante avec platine à visser, support : acier industriel revêtu par poudre, roue : noire, couleur aluminium, surface : soft

														1x			Code	EAN-Code 4001073 ...
50	19	X	X	63	15	42x42	32	4	50					X			03 3253 01	...006254
75	23	X	X	96	27	60x60	44	6x8	50					X			03 3283 01	...006353



Möbel-Lenkrolle mit Anschraubplatte, Gehäuse: Zinkdruckguss, vernickelt, Rad: schwarz, vernickelt

Swivel castor for furniture, with screw-on plate, casing: made of die-cast zinc, nickered, wheel: black, nickered

Roulette pivotante pour meubles, avec blocage, support : zinc coulé nickelé, roue : noire, nickelé

														1x			Code	EAN-Code 4001073 ...
42	15	X	70	19	36x56	21x41	5	35						X			01 0084 01	...006056
51	18	X	79	19	36x56	21x41	5	50						X			01 0085 01	...006148
62	21	X	90	19	36x56	21x41	5	60						X			01 0086 01	...006155



Design-Lenkrolle mit Anschraubpl., Gehäuse: Ind.-stahl, verzinkt, Rad: hochw. Kunststoff (PC), transp., Lauffläche: soft total

Design swivel castor with screw-on plate, casing: industrial steel, galvanised, wheel: high-quality plastic (PC), transparent, tread: completely soft

Roulette design pivotante avec platine à visser, support : acier industriel, zingué, roue : plastique de haute qualité (PC), transparente, surface : complètement soft

													1x			Code	EAN-Code
35	24	X	X	50	18	42x42	32	4	35				X			03 1035 01	...041347



Design-Lenkrolle mit Anschraubpl., Gehäuse: Ind.-stahl, verzinkt, Rad: hochw. Kunststoff (PC), transp., Lauffläche: soft total

Design swivel castor with screw-on plate, casing: industrial steel, galvanised, wheel: high-quality plastic (PC), transparent, tread: completely soft

Roulette design pivotante avec platine à visser, support : acier industriel, zingué, roue : plastique de haute qualité (PC), transparente, surface : complètement soft

													1x			Code	EAN-Code
50	21	X	X	64	18	42x42	32	4	40				X			03 1085 01	...005653



Design-Lenkrolle mit Anschraubp. und Festst., Gehäuse: Ind.-stahl, verzinkt, Rad: hochw. Kunststoff (PC), transp., Lauffläche: soft total

Design swivel castor with screw-on plate and brake, casing: industrial steel, galvanised, wheel: high-quality plastic (PC), transparent, tread: completely soft

Roulette design pivotante avec platine à visser et blocage, support : acier industriel, zingué, roue : plastique de haute qualité (PC), transparente, surface : complètement soft

													1x			Code	EAN-Code
50	21	X	X	64	18	42x42	32	4	40				X			03 3085 01	...005745
60	23	X	X	80	25	60x60	45	6	50				X			03 3086 01	...005844
75	23	X	X	97	27	60x60	45	6	55				X			03 3087 01	...005943
100	23	X	X	125	35	60x60	45	6	65				X			03 3088 01	...006094

Möb

elrollen

Bockrollen / Lenkrollen / Kastenrollen

Fixed castors for furniture

Swivel castors for furniture

Castors for bed frame

Roulettes fixes pour meubles

Roulettes pivotantes pour meubles

Roulettes de caissons pour meubles

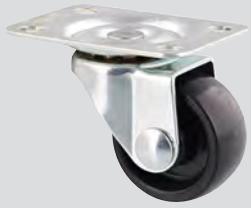

Möbel-Lenkrolle mit Anschraubplatte, Gehäuse: Industriestahl, verzinkt, Rad: Polyamid, schwarz

Swivel castor for furniture with screw-on plate, casing: industrial steel, galvanised, wheel: polyamid, black

Roulette pivotante pour meubles avec platine à visser, support : acier industriel, zingué, roue : polyamide, noire

Ø	h	Ø	Ø	Ø	Ø	Ø	Ø	kg					1x		PE	Code	EAN-Code 4001073 ...
25	15	X	35	13	34x48	22x35	5	15					X			01 2105 01	...009163
30	12	X	38	13	33x48	22x35	5	15					X			01 2109 01	...019513
30	12	X	38	13	33x48	22x35	5	15						20		02 2109 20	...019575



Möbel-Lenkrolle mit Anschraubplatte, Gehäuse: Industriestahl, verzinkt, Rad: Polyamid, schwarz

Swivel castor for furniture with screw-on plate, casing: industrial steel, galvanised, wheel: polyamid, black

Roulette pivotante pour meubles avec platine à visser, support : acier industriel, zingué, roue : polyamide, noire

Ø	h	Ø	Ø	Ø	Ø	Ø	Ø	kg					1x		PE	Code	EAN-Code 4001073 ...
29	15	X	49	19	38x38	29	4	30					X			01 2110 01	...019612



Möbel-Lenkrolle mit Anschraubplatte, Gehäuse: Industriestahl, verzinkt, Rad: Polyamid, schwarz

Swivel castor for furniture with screw-on plate, casing: industrial steel, galvanised, wheel: polyamid, black

Roulette pivotante pour meubles avec platine à visser, support : acier industriel, zingué, roue : polyamide, noire

Ø	h	Ø	Ø	Ø	Ø	Ø	Ø	kg					1x		PE	Code	EAN-Code 4001073 ...
40	19	X	56	13	42x42	30	5	35					X			01 2120 01	...019711
40	19	X	56	13	42x42	30	5	35						8		02 2120 00	...019728
40	19	X	56	13	42x42	30	5	35						8		02 2121 00	...020830



Möbel-Lenkrolle mit Anschraubplatte, Gehäuse: Industriestahl, verzinkt, Rad: Polyethylen, transparent

Swivel castor for furniture with screw-on plate, casing: industrial steel, galvanised, wheel: polyethylene, transparent

Roulette pivotante pour meubles avec platine à visser, support : acier industriel, zingué, roue : polyéthylène, transparente

													1x			Code	EAN-Code
25	13	X	34	15	47x33	35x22	5	15					X			01 2155 01	...236491
30	13	X	38	15	47x33	35x22	5	15					X			01 2156 01	...236590



Möbel-Lenkrolle mit Anschraubplatte, Gehäuse: Industriestahl, verzinkt, Rad: Polyethylen, transparent

Swivel castor for furniture with screw-on plate, casing: industrial steel, galvanised, wheel: polyethylene, transparent

Roulette pivotante pour meubles avec platine à visser, support : acier industriel, zingué, roue : polyéthylène, transparente

													1x			Code	EAN-Code
40	17	X	53	19	42x42	30	5	35					X			01 2157 01	...533491



Möbel-Lenkrolle mit Anschraubplatte, Gehäuse: Industriestahl, verzinkt, Rad: hochw. Kunststoff (PUR), rot, Lauffläche: soft
 Swivel castor for furniture, with screw-on plate, casing: industrial steel, galvanised, wheel: high-quality plastic (PUR), red, tread: soft

Roulette pivotante pour meubles, avec platine à visser, support : acier industriel, zingué, roue : plastique de haute qualité (PUR), rouge, surface : soft

													1x			Code	EAN-Code
30	16	X	X	51	18	36x46	24x34	5	30				X			01 2130 01	...001884
40	16	X	X	57	20	36x46	24x34	5	40				X			01 2140 01	...001891



Möbel-Lenkrolle mit Anschraubplatte, Gehäuse: Industriestahl, verzinkt, Rad: hochw. Kunststoff (PUR), rot, Lauffläche: soft
 Swivel castor for furniture, with screw-on plate, casing: industrial steel, galvanised, wheel: high-quality plastic (PUR), red, tread: soft

Roulette pivotante pour meubles, avec platine à visser, support : acier industriel, zingué, roue : plastique de haute qualité (PUR), rouge, surface : soft

													1x			Code	EAN-Code
50	17	X	X	X	72	24	57x71	38x54	7	50			X			01 2150 01	...001969
60	17	X	X	X	83	24	57x71	38x54	7	60			X			01 2160 01	...001983

Nicht nur bei den Komponenten einer Rolle ist die richtige Kombination von Bedeutung. Sie bestimmt auch die Manövrierbarkeit von Möbel oder Gerät bei unterschiedlichen Anforderungen. Hier entscheiden Auswahl, Anordnung und Ausstattung der Rollen:

Not only the components of a castor play a large roll in the right combination, it also distinguishes the manoeuvrability of the furniture or appliance for the different requirements. Decisive is the choice, design and allocation of the castor:

Non seulement le choix des composants d'une roulette est important mais son choix définit aussi la mobilité et la manutention d'un meuble ou d'un appareil en fonction de circonstances différentes. Ici entre en compte, choix, équipement et adaptation:

high move

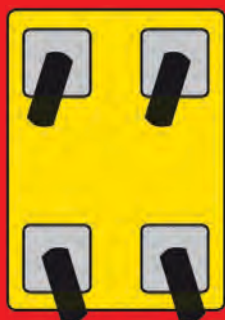

4 Lenkrollen:

- Uneingeschränkte Beweglichkeit in alle Richtungen
- Kleiner Wendekreis
- Ohne Feststeller: Fester Stand, bei unebenem Boden Wegrollgefahr
- Mit zwei Feststellern: Sicherer Stand, kaum Wegrollgefahr
- Mit vier Feststellern: Absolut sicherer Stand, keinerlei Wegrollgefahr

4 Swivel castors:

- Unrestricted motion in all directions
- Small turning point
- Without brake: solid grip, danger of rolling on uneven surfaces
- With two brakes: secure grip, minimal danger of rolling
- With four brakes: absolute secure grip, no danger of rolling

4 Roulettes pivotantes:

- Mobilité indéfinie dans toutes les directions
- Pas de rayon de braquage
- Sans frein, pas de déplacement accidentel sur sol en pente
- Avec deux roulettes à frein, blocage sur place, pas de risque de déplacement non contrôlé
- Avec quatre roulettes à frein, blocage absolu, roulant dans aucun sens

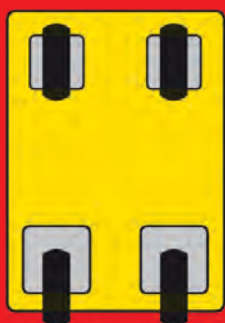

2 Lenkrollen + 2 Bockrollen:

- Guter Geradeauslauf, gute Kurvenlage
- Mittlerer Wendekreis
- Ohne Feststeller: Fester Stand, bei unebenem Boden Wegrollgefahr
- Mit zwei Feststellern: Sicherer Stand, kaum Wegrollgefahr

2 Swivel castors +

2 Fixed castors:

- Good straight rolling, good curve control
- Half turning point
- Without brake: solid grip, danger of rolling on uneven surfaces
- With two brakes: secure grip, minimal danger of rolling

2 Roulettes pivotantes +

2 Roulettes fixes

- Bon déplacement droit et prise de virages
- Rayon de braquage moyen
- Sans frein, position fixe avec le risque de déplacement non contrôlé sur des surfaces inégales
- Avec deux roulettes à frein, position fixe, risque minimal de déplacement accidentel

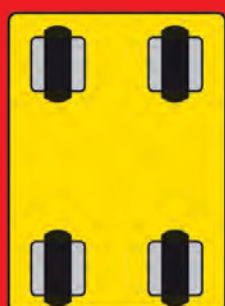

4 Bockrollen:

- Ideale Kombination für spurge-radten Geradeauslauf
- Großer Wendekreis
- Ohne Feststeller: Fester Stand, bei unebenem Boden Wegrollgefahr

4 Fixed castors:

- Ideal combination for straight rolling characteristics
- Large turning point
- Without brakes: solid grip, danger of rolling on uneven surfaces

4 Roulettes fixes

- Combinaison idéale pour un déplacement rectiligne
- Grand rayon de braquage
- Sans frein, risque de déplacement accidentel par sol inégal



Möbel-Lenkrolle 3C-Serie mit Anschraubplatte, Rad: hochw. Kunststoff (TPE), Lauffläche: soft

Swivel castor for furniture 3C-Series, with screw-on plate, wheel: high-quality plastic (TPE), tread: soft

Roulette pivotante pour meubles série 3C, avec platine à visser, roue : plastique de haute qualité (TPE), surface : soft

50	75	20	25	X	X	73	100	48x58	59x71	32x45	38x52	5	8	50	75	1x	PE	Code	EAN-Code
		X	X	X	X											X		01 2250 01	...221558
		X	X	X	X											X		01 2275 01	...419528



Möbel-Lenkrolle 3C-Serie mit Anschraubplatte und Feststeller, Rad: hochw. Kunststoff (TPE), Lauffläche: soft

Swivel castor for furniture 3C-Series, with screw-on plate and brake, wheel: high-quality plastic (TPE), tread: soft

Roulette pivotante pour meubles série 3C, avec platine à visser à visser et blocage, roue : plastique de haute qualité (TPE), surface : soft

50	75	20	25	X	X	73	100	48x58	59x71	32x45	38x52	5	8	50	75	1x	PE	Code	EAN-Code
		X	X	X	X											X		01 2350 01	...221855
		X	X	X	X											X		01 2375 01	...334692



Möbel-Bockrolle 3C-Serie mit Anschraubplatte, Rad: hochw. Kunststoff (TPE), Lauffläche: soft

Equipment fixed castor 3C-Series, with screw-on plate, wheel: high-quality plastic (TPE), tread: soft

Roulette d'appareil fixe série 3C, avec platine à visser, roue : plastique de haute qualité (TPE), surface : soft

50	75	20	25	X	X	73	100	48x59	59x71	32x45	38x52	6	8	50	75	1x	PE	Code	EAN-Code
		X	X	X	X											X		01 2450 01	...176674
		X	X	X	X											X		01 2475 01	...227697



Möbel-Lenkrolle 3C-Serie mit Anschraubplatte, Rad: hochw. Kunststoff (TPE), Lauffläche: soft

Swivel castor for furniture 3C-Series, with screw-on plate, wheel: high-quality plastic (TPE), tread: soft

Roulette pivotante pour meubles série 3C, avec platine à visser, roue : plastique de haute qualité (TPE), surface : soft

50	20	X	X	73	48x58	32x45	5	50							1x		PE	Code	EAN-Code
50	20	X	X	73	48x58	32x45	5	50							X			01 2251 01	...449051
75	25	X	X	100	59x71	38x52	8	75							X			01 2276 01	...378283



Möbel-Lenkrolle 3C-Serie mit Anschraubplatte und Feststeller, Rad: hochw. Kunststoff (TPE), Lauffläche: soft

Swivel castor for furniture 3C-Series, with screw-on plate and brake, wheel: high-quality plastic (TPE), tread: soft

Roulette pivotante pour meubles série 3C, avec platine à visser à visser et blocage, roue : plastique de haute qualité (TPE), surface : soft

50	20	X	X	73	48x58	32x45	5	50							1x		PE	Code	EAN-Code
50	20	X	X	73	48x58	32x45	5	50							X			01 2351 01	...251746
75	25	X	X	100	59x71	38x52	8	75							X			01 2376 01	...081282



Möbel-Lenkrolle-Set 3C-Serie mit Anschraubplatte, mit und ohne Feststeller, Rad: hochw. Kunststoff (TPE), Lauffläche: soft

Set of swivel castors for furniture 3C-Series, with screw-on plate, with and without brake, wheel: high-quality plastic (TPE), tread: soft

Set de roulettes pivotantes pour meubles série 3C, avec platine à visser, avec et sans blocage, roue : plastique de haute qualité (TPE), surface : soft

25	12	X	X		42	30x38	20x28	4	12						1x		PE	Code	EAN-Code
25	12	X	X		42	30x38	20x28	4	12						4			02 2226 04	...400656
50	20	X		X	73	48x58	32x45	5	50						4			02 2251 04	...010299
75	25	X		X	100	59x71	38x52	8	75						2			02 2276 02	...399943



Möbel-Lenkrolle 3C-Serie mit Anschraubplatte, Rad: hochw. Kunststoff (TPE), Lauffläche: soft

Swivel castor for furniture 3C-Series, with screw-on plate, wheel: high-quality plastic (TPE), tread: soft

Roulette pivotante pour meubles série 3C, avec platine à visser, roue : plastique de haute qualité (TPE), surface : soft

50	20	X	X	73	48x58	32x45	5	50							1x		PE	Code	EAN-Code
50	20	X	X	73	48x58	32x45	5	50							X			01 2252 01	...081886
75	25	X	X	100	59x71	38x52	8	75							X			01 2277 01	...449020



Möbel-Lenkrolle 3C-Serie mit Anschraubplatte und Feststeller, Rad: hochw. Kunststoff (TPE), Lauffläche: soft

Swivel castor for furniture 3C-Series, with screw-on plate and brake, wheel: high-quality plastic (TPE), tread: soft

Roulette pivotante pour meubles série 3C, avec platine à visser à visser et blocage, roue : plastique de haute qualité (TPE), surface : soft

50	20	X	X	73	48x58	32x45	5	50							1x		PE	Code	EAN-Code
50	20	X	X	73	48x58	32x45	5	50							X			01 2352 01	...251043
75	25	X	X	100	59x71	38x52	8	75							X			01 2377 01	...251432



Möbel-Lenkrolle-Set 3C-Serie mit Anschraubplatte, mit und ohne Feststeller, Rad: hochw. Kunststoff (TPE), Lauffläche: soft

Set of swivel castors for furniture 3C-Series, with screw-on plate, with and without brake, wheel: high-quality plastic (TPE), tread: soft

Set de roulettes pivotantes pour meubles série 3C, avec platine à visser, avec et sans blocage, roue : plastique de haute qualité (TPE), surface : soft

25	12	X	X		42	30x38	20x28	4	12						1x		PE	Code	EAN-Code
25	12	X	X		42	30x38	20x28	4	12						4			02 2227 04	...009064
50	20	X		X	73	48x58	32x45	5	50						4			02 2252 04	...010664
75	25	X		X	100	59x71	38x52	8	75						2			02 2277 02	...201604



Möbel-Lenkrolle 3C-Serie mit Rückenloch, Rad: hochwertiger Kunststoff (TPE), Lauffläche: soft

Swivel castor for furniture 3C-Series, with back-hole, wheel: high-quality plastic (TPE), tread: soft

Roulette pivotante pour meubles série 3C, avec trou au dos, roue : plastique de haute qualité (TPE), surface : soft

													1x			Code	EAN-Code
50	20	X	X	73	25	10	43	X	50				X			01 1252 01	...044065
75	25	X	X	100	35	10	50	X	75				X			01 1277 01	...044379



Möbel-Lenkrolle 3C-Serie mit Rückenloch und Feststeller, Rad: hochwertiger Kunststoff (TPE), Lauffläche: soft

Swivel castor for furniture 3C-Series, with back-hole and brake, wheel: high-quality plastic (TPE), tread: soft

Roulette pivotante pour meubles série 3C, avec trou au dos et blocage, roue : plastique de haute qualité (TPE), surface : soft

													1x			Code	EAN-Code
50	20	X	X	73	25	10	43	X	50				X			01 3352 01	...226140
75	25	X	X	100	35	10	50	X	75				X			01 3377 01	...044171





Möbel-Lenkrolle 3C-Serie mit Stift, Rad: hochw. Kunststoff (TPE), Lauffläche: soft

Swivel castor for furniture 3C-Series, with stem, wheel: high-quality plastic (TPE), tread: soft

Roulette pivotante pour meubles série 3C, avec tige, roue : plastique de haute qualité (TPE), surface : soft

		soft											1x		Code	EAN-Code
50	20	X	X	73	25	11x22	37	50					X		01 2252 61	...092455
50	20	X	X	73	25	11x22	37	50						5	02 2252 61	...290240



Möbel-Lenkrolle 3C-Serie mit Stift, Rad: hochw. Kunststoff (TPE), Lauffläche: soft

Swivel castor for furniture 3C-Series, with stem, wheel: high-quality plastic (TPE), tread: soft

Roulette pivotante pour meubles série 3C, avec tige, roue : plastique de haute qualité (TPE), surface : soft

		soft											1x		Code	EAN-Code
75	25	X	X	100	35	11x22	46	75					X		01 2277 61	...093643



Möbel-Lenkrolle 3C-Serie mit Gewindestift, Rad: hochw. Kunststoff (TPE), Lauffläche: soft

Swivel castor for furniture 3C-Series, with galvanised threaded stem, wheel: high-quality plastic (TPE), tread: soft

Roulette pivotante pour meubles série 3C, avec tige filetée, roue : plastique de haute qualité (TPE), surface : soft

														1x			Code	EAN-Code
50	20	X	X	73	25	10x16	37	50						X			01 2252 66	...218121
75	25	X	X	100	35	10x16	46	75						X			01 2277 66	...417722



Möbel-Lenkrolle 3C-Serie mit Gewindestift und Feststeller, Rad: hochw. Kunststoff (TPE), Lauffläche: soft

Swivel castor for furniture 3C-Series, with galvanised threaded stem and brake, wheel: high-quality plastic (TPE), tread: soft

Roulette pivotante pour meubles série 3C, avec tige filetée et blocage, roue : plastique de haute qualité (TPE), surface : soft

														1x			Code	EAN-Code
50	20	X	X	73	25	10x16	37	50						X			01 2352 66	...218749
75	25	X	X	100	35	10x16	46	75						X			01 2377 66	...216554



Möbel-Lenkrolle 3C-Serie mit Stift, verchromt, Rad: hochw. Kunststoff (TPE), Lauffläche: soft

Swivel castor for furniture 3C-Series, with stem, chromium-plated, wheel: high-quality plastic (TPE), tread: soft

Roulette pivotante pour meubles série 3C, avec tige, chromer, roue : plastique de haute qualité (TPE), surface : soft

		soft											1x			Code	EAN-Code
50	20	X	X	73	25	11x22	20	50					X			01 2254 61	4001073291230



Möbel-Lenkrolle 3C-Serie mit Stift, verchromt, Rad: hochw. Kunststoff (TPE), Lauffläche: soft

Swivel castor for furniture 3C-Series, with stem, chromium-plated, wheel: high-quality plastic (TPE), tread: soft

Roulette pivotante pour meubles série 3C, avec tige, chromer, roue : plastique de haute qualité (TPE), surface : soft

		soft											1x			Code	EAN-Code
75	25	X	X	100	35	11x22	46	75					X			01 2279 61	4001073292305



Appara

terollen

Equipment castors
Roulettes d'appareil

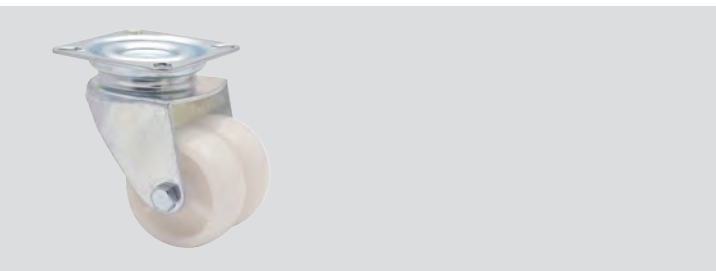

Apparate-Lenk-Doppelrolle ECO mit Anschraubplatte, Gehäuse: Industriestahl, verzinkt, Rad: Polyamid, weiß

Twin wheel equipment swivel castor ECO, with screw-on plate, casing: industrial steel, galvanised, wheel: polyamide, white

Roulette d'appareil à double roue pivotante ECO, avec platine à visser, support : acier industriel, zingué, roue : polyamide, blanche

50	20	X	73	25	60x60	43	6	70							1x		PE	Code	EAN-Code
50	20	X	73	25	60x60	43	6	70							X			03 1252 01	...078404
75	23	X	103	25	77x67	55x48	8	100							X			03 1277 01	...007152



Apparate-Lenk-Doppelrolle ECO mit Anschraubp. u. T-Feststeller, Gehäuse: Industriestahl, verzinkt, Rad: Polyamid, weiß

Twin wheel equipment swivel castor ECO, with screw-on plate and total brake, casing: industrial steel, galvanised, wheel: polyamide, white

Roulette d'appareil à double roue pivotante ECO, avec platine à visser et blocage total, support : acier industriel, zingué, roue : polyamide, blanche

50	20	X	73	25	60x60	43	6	70							1x		PE	Code	EAN-Code
50	20	X	73	25	60x60	43	6	70							X			03 3252 01	...007145
75	23	X	103	25	77x67	55x48	8	100							X			03 3277 01	...007244



Apparate-Lenk-Doppelrolle ECO mit Anschraubp., Gehäuse: Ind.-stahl, verzinkt, Rad: hochw. Kunstst./TPR, Lauffläche: Ultrasoft
 Twin wheel equipment swivel castor ECO with screw-on plate, casing: industrial steel, galvanised, wheel: high-quality plastic /TPR, tread: Ultrasoft

Roulette d'appareil pivotante à double roue ECO avec platine à visser, support : acier industriel, zingué, roue : plastique de haute qualité / TPR, surface : Ultrasoft

50	75	20	23	X	X	X	X	73	103	25	25	60x60	77x67	43	55x48	6	8	70	100	1x	PE	Code	EAN-Code
		X	X	X	X	X	X													X		03 1552 01	...056648
		X	X	X	X	X	X													X		03 1577 01	...056709



App.-Lenk-Doppelrolle ECO mit Anschraubp. u. T-Festst., Gehäuse: Ind.stahl, verzinkt, Rad: hochw. Kunstst./TPR, Lauffl.: Ultrasoft
 Twin wheel equipment swivel castor ECO with screw-on plate and total brake, casing: industrial steel, galvanised, wheel: high-quality plastic /TPR, tread: Ultrasoft

Roulette d'appareil pivotante à double roue ECO avec platine à visser et blocage total, support : acier industriel, zingué, roue : plastique de haute qualité /TPR, surface : Ultrasoft

50	75	20	23	X	X	X	X	73	103	25	25	60x60	77x67	43	55x48	6	8	70	100	1x	PE	Code	EAN-Code
		X	X	X	X	X	X													X		03 3552 01	...056655
		X	X	X	X	X	X													X		03 3577 01	...056730



Apparate-Lenkrolle mit Eck-Anschraubplatte, Gehäuse: Ind.-stahl, verzinkt, Rad: hochw. Kunstst./TPR, Lauffläche: Ultrasoft
 Equipment swivel castor with corner screw-on plate, casing: industrial steel, galvanised, wheel: high-quality plastic /TPR, tread: Ultrasoft

Roulette d'appareil pivotante avec platine à visser en angle, support : acier industriel, zingué, roue : plastique de haute qualité / TPR, surface : Ultrasoft

50	50	20	20	X	X	X	X	72	72	25	25	35x35	35x35			23x7	23x7	50	50	1x	PE	Code	EAN-Code
		X	X	X	X	X	X													X		03 3150 01	...402650
		X	X	X	X	X	X													4		02 3150 00	...294842



Apparate-Lenkrolle mit Anschraubplatte, Gehäuse: Industriestahl, verzinkt, Rad: Polyamid, weiß

Equipment swivel castor with screw-on plate, casing: industrial steel, galvanised, wheel: polyamide, white

Roulette d'appareil pivotante avec platine à visser, support : acier industriel, zingué, roue : polyamide, blanche

Ø	h	Ø	Ø	Ø	Ø	Ø	Ø	kg							1x		PE	Code	EAN-Code 4001073 ...
50	20	X	72	25	50x50	35	6	50							X			03 1250 01	...056129
50	20	X	72	25	50x50	35	6	50									4	02 1250 00	...020823
75	25	X	100	30	60x60	42	6	60						X				03 1675 01	...051834



Apparate-Lenkrolle mit Anschraubplatte und Totalfeststeller, Gehäuse: Industriestahl, verzinkt, Rad: Polyamid, weiß

Equipment swivel castor with screw-on plate and total brake, casing: industrial steel, galvanised, wheel: polyamide, white

Roulette d'appareil pivotante avec platine à visser et blocage total, support : acier industriel, zingué, roue : polyamide, blanche

Ø	h	Ø	Ø	Ø	Ø	Ø	Ø	kg							1x		PE	Code	EAN-Code 4001073 ...
50	20	X	72	25	50x50	35	6	50							X			03 3250 01	...056136
75	25	X	100	30	60x60	42	6	60						X				03 3675 01	...051841
125	26	X	154	32	75x75	54	8	90						X				03 3625 01	...056235

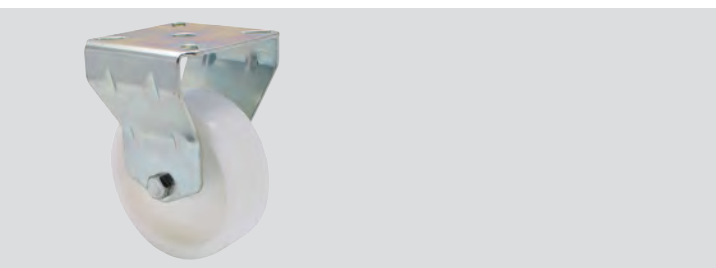

Apparate-Bockrolle mit Anschraubplatte, Gehäuse: Industriestahl, verzinkt, Rad: Polyamid, weiß

Equipment fixed castor with screw-on plate, casing: industrial steel, galvanised, wheel: polyamide, white

Roulette d'appareil fixe avec platine à visser, support : acier industriel, zingué, roue : polyamide, blanche

Ø	h	Ø	Ø	Ø	Ø	Ø	kg								1x		PE	Code	EAN-Code 4001073 ...
50	20	X	72	60x60	48	6	50								X			23 7250 01	...056143
75	25	X	100	60x60	42	6	60							X				23 7675 01	...051858



Apparate-Lenkrolle mit Rückenloch, Gehäuse: Industriestahl, verzinkt, Rad: Polyamid, weiß
 Equipment swivel castor with back-hole, casing: industrial steel, galvanised, wheel: polyamide, white
 Roulette d'appareil pivotante avec trou au dos, support : acier industriel, zingué, roue : polyamide, blanche

Ø	h	Ø	Ø	h	h	h	+	kg						1x		PE	Code	EAN-Code 4001073 ...
50	20	X	71	25	10	41	X	50						X			23 1250 01	...015331
75	25	X	100	30	10	45	X	60						X			23 1675 01	...051902
100	26	X	127	31	10	56	X	75						X			23 1600 01	...051728
125	26	X	152	32	10	56	X	90						X			23 1625 01	...056259



Apparate-Lenkrolle mit Rückenloch und Totalfeststeller, Gehäuse: Industriestahl, verzinkt, Rad: Polyamid, weiß
 Equipment swivel castor with back-hole and total brake, casing: industrial steel, galvanised, wheel: polyamide, white
 Roulette d'appareil pivotante avec trou au dos et blocage total, support : acier industriel, zingué, roue : polyamide, blanche

Ø	h	Ø	Ø	h	h	h	+	kg						1x		PE	Code	EAN-Code 4001073 ...
50	20	X	71	25	10	41	X	50						X			23 3250 01	...015348
75	25	X	89	30	10	45	X	60						X			23 3675 01	...051919
100	26	X	127	31	10	56	X	75						X			23 3600 01	...051735
125	26	X	152	32	10	56	X	90						X			23 3625 01	...056440



Ersatzrad für Apparaterolle, Rad: Polyamid, weiß
 Spare wheel for equipment castor, wheel: polyamide, white
 Roue de rechange pour roulette d'appareil, roue : polyamide, blanche

Ø	h	Ø	Ø	h	kg									1x		PE	Code	EAN-Code 4001073 ...
50	20	X	8	22	50									X			03 6250 01	...405552
75	25	X	8	30	60									X			03 6675 01	...405439
125	26	X	12	33	90									X			03 6625 01	...405453



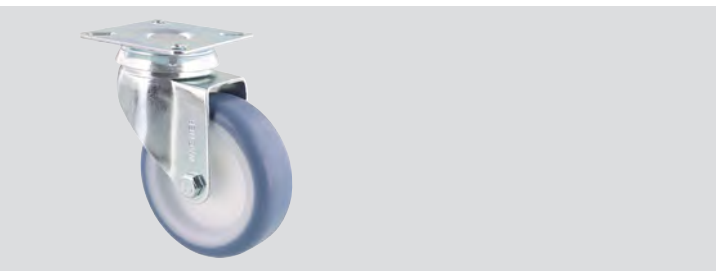

Apparate-Lenkrolle mit Anschraubplatte, Gehäuse: Industriestahl, verzinkt, Rad: hochwertiger Kunststoff/TPR, Lauffläche: Ultrasoft
 Equipment swivel castor with screw-on plate, casing: industrial steel, galvanised, wheel: high-quality plastic/TPR, tread: Ultrasoft
 Roulette d'appareil pivotante avec platine à visser, support : acier industriel, zingué, roue : plastique de haute qualité/TPR, surface : Ultrasoft

Wheel Diameter	Plate Width	ULTRA soft	ULTRA soft	Wheel Diameter	Wheel Width	Plate Size	Plate Size	Plate Size	Weight (kg)	Weight	Weight	Weight	Weight	Weight	Weight	1x	PE	Code	EAN-Code 4001073 ...
50	20	X	X	72	25	50x50	35	6	50						X			03 1550 01	...056303
50	20	X	X	72	25	50x50	35	6	50								4	02 1550 00	...053128
75	25	X	X	100	30	60x60	42	6	60						X			03 1775 01	...051926
100	27	X	X	130	31	75x75	54	8	75						X			03 1700 01	...051742



Apparate-Lenkrolle mit Anschraubp. u. T-Festst., Gehäuse: Ind. stahl, verzinkt, Rad: hochw. Kunstst./TPR, Lauffläche: Ultrasoft
 Equipment swivel castor with screw-on plate and total brake, casing: industrial steel, galvanised, wheel: high-quality plastic/TPR, tread: Ultrasoft

Roulette d'appareil pivotante avec platine à visser et blocage total, support : acier industriel, zingué, roue : plastique de haute qualité/TPR, surface : Ultrasoft

Wheel Diameter	Plate Width	ULTRA soft	ULTRA soft	Wheel Diameter	Wheel Width	Plate Size	Plate Size	Plate Size	Weight (kg)	Weight	Weight	Weight	Weight	Weight	Weight	1x	PE	Code	EAN-Code 4001073 ...
50	20	X	X	72	25	50x50	35	6	50						X			03 3550 01	...056150
75	25	X	X	100	30	60x60	42	6	60						X			03 3775 01	...051933
100	27	X	X	130	31	75x75	54	8	75						X			03 3700 01	...051759

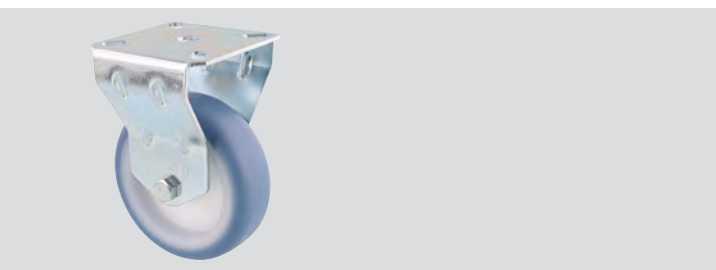

Apparate-Bockrolle mit Anschraubplatte, Gehäuse: Industriestahl, verzinkt, Rad: hochwertiger Kunststoff/TPR, Lauffläche: Ultrasoft
 Equipment fixed castor with screw-on plate, casing: industrial steel, galvanised, wheel: high-quality plastic/TPR, tread: Ultrasoft
 Roulette d'appareil fixe avec platine à visser, support : acier industriel, zingué, roue : plastique de haute qualité/TPR, surface : Ultrasoft

Wheel Diameter	Plate Width	ULTRA soft	ULTRA soft	Wheel Diameter	Wheel Width	Plate Size	Plate Size	Plate Size	Weight (kg)	Weight	Weight	Weight	Weight	Weight	Weight	1x	PE	Code	EAN-Code 4001073 ...
50	20	X	X	72	60x60	48	6	50							X			23 7550 01	...056204
75	25	X	X	100	60x60	42	6	60							X			23 7775 01	...015940
100	27	X	X	130	75x75	54	8	75							X			23 7700 01	...051803



Apparate-Lenkrolle mit Rückenloch, Gehäuse: Industriestahl, verzinkt, Rad: hochwertiger Kunststoff/TPR, Lauffläche: Ultrasoft

Equipment swivel castor with back-hole, casing: industrial steel, galvanised, wheel: high-quality plastic/TPR, tread: Ultrasoft

Roulette d'appareil pivotante avec trou au dos, support : acier industriel, zingué, roue : plastique de haute qualité/TPR, surface : Ultrasoft

Ø	h	ULTRA soft	Ø	h	h	h	h	+	kg				1x	PE	Code	EAN-Code 4001073 ...
50	20	X	X	70	25	10	41	X	50				X		23 1550 01	...056457
75	25	X	X	98	30	10	45	X	60				X		23 1775 01	...051957
100	27	X	X	127	31	10	56	X	75				X		23 1700 01	...051810



Apparate-Lenkrolle mit Rückenloch u. T-Festst., Gehäuse: Ind. stahl, verzinkt, Rad: hochw. Kunstst./TPR, Lauffläche: Ultrasoft

Equipment swivel castor with back-hole and total brake, casing: industrial steel, galvanised, wheel: high-quality plastic/TPR, tread: Ultrasoft

Roulette d'appareil pivotante avec trou au dos, et blocage total, support : acier industriel, zingué, roue: plastique de haute qualité/TPR, surface : Ultrasoft

Ø	h	ULTRA soft	Ø	h	h	h	h	+	kg				1x	PE	Code	EAN-Code 4001073 ...
50	20	X	X	70	25	10	41	X	50				X		23 3550 01	...056501
75	25	X	X	98	30	10	45	X	60				X		23 3775 01	...052008
100	27	X	X	127	31	10	56	X	75				X		23 3700 01	...051827

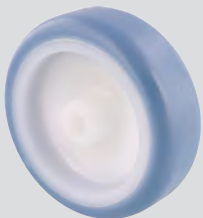

Ersatzrad für Apparaterolle, Rad: hochwertiger Kunststoff/TPR, Lauffläche: Ultrasoft

Spare wheel for equipment castor, wheel: high-quality plastic/TPR, tread: Ultrasoft

Roue de rechange pour roulette d'appareil, roue : plastique de haute qualité/TPR, surface : Ultrasoft

Ø	h	ULTRA soft	Ø	h	h	kg							1x	PE	Code	EAN-Code 4001073 ...
50	20	X	X	8	24	50							X		03 6550 01	...405606
75	25	X	X	8	30	60							X		03 6775 01	...405521
100	27	X	X	12	29	75							X		03 6700 01	...405538



WAGNER - quality tested

Die „**Ultrasoft**“-Serie von **WAGNER** wurde einer Reihe von **Prüfungen und Belastungs-Tests** unterzogen. Auf speziellen Prüfmaschinen wurden die Rollen vollautomatisch auf Qualität und Sicherheit getestet. U.a. wurden folgende Teststationen erfolgreich absolviert:

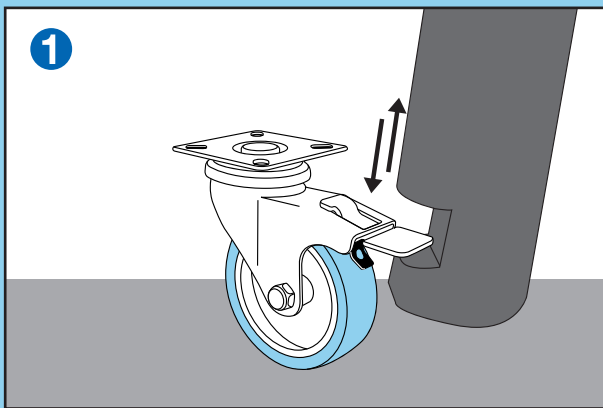

1 Teststation: Feststellbremse

Mittels eines pneumatischen Hebelarms wurde der Rollen-Totalfeststeller **über 1.000 x fixiert** und anschließend wieder gelöst. Das Ergebnis: Der Totalfeststeller wies trotz dieser massiven Belastung keinerlei Verschleiß auf und war auch über den Test hinaus voll funktionsfähig.

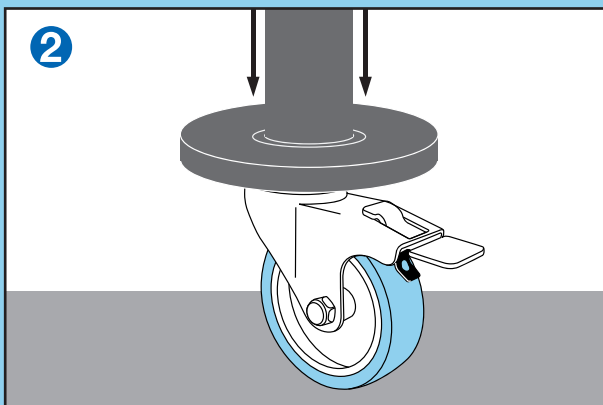

2 Teststation: Tragkraft

Der Belastungstest der Ultrasoft-Rolle wurde – im Vergleich zur ausgewiesenen Tragkraft - mit einer **verdoppelten Gewichtbelastung** durchgeführt. Das Ergebnis: Die Rollen hielten dieser extremen Belastung nachhaltig stand - sowohl hinsichtlich Qualität als auch Beweglichkeit.

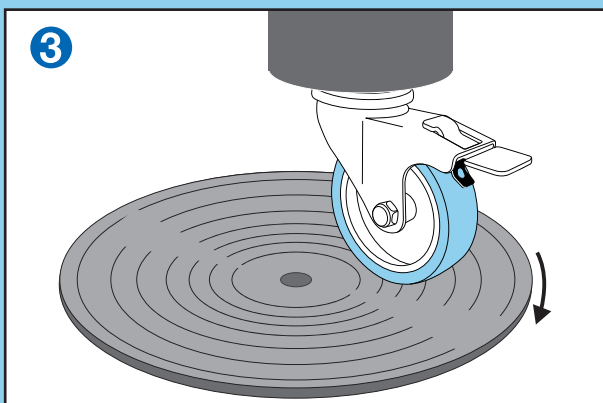

3 Teststation: Lauffläche

Eingespannt in eine Drehtellervorrichtung wurden Ultrasoft-Rollen auf einer Prüfstrecke von **über 5.000 m** hinsichtlich Verschleiß und Abnutzung überwacht. Das Ergebnis: Die Ultrasoft-Oberfläche wies im Vergleich zu herkömmlichen Soft-Rollen einen weit geringeren Abnutzungsgrad auf.



WAGNER - quality tested

The „**Ultrasoft**“ line made by **WAGNER** were subject to a series of **checks and endurance tests**. On special testing machines the castors had been tested fully automatic for quality and safety. Inter alia, the following test stations had been successfully absolved:

1 Test station: total brake

Via a pneumatic lever the castor's total brake had been **fixed and released more than 1.000 times**. The result: In spite of this massive stress, there were no signs of wear-out at all and the brake was fully functioning even after the test.

2 Test station: load capacity

The load capacity test of the Ultrasoft castor had been performed – in comparison to the declared load capacity – with a **doubled weight load**. The result: the castors resisted strongly to this extreme weight – as well as regarding quality as also mobility.

3 Test station: tread

Clamped into a rotary table device, the Ultrasoft castors had been controlled on a test distance of **more than 5.000 m** regarding wear-out and abrasion. The result: the Ultrasoft surface showed, a much lower grade of abrasion, compared with conventional soft castors.

WAGNER - qualité testée

La ligne “**Ultrasoft**” de **WAGNER** a été soumise à une série **des tests concernant vérification et chargement**. Sur des machines spéciaux de test on a testé les roulettes entièrement automatique à qualité et sécurité. Entre autres, les stations de test suivantes ont été effectuées avec succès :

1 Station de test: blocage total

Moyennant un bras de levier pneumatique le blocage total de la roulette a été **fixé plus de 1.000 fois** et ensuite desserré. Le résultat : le blocage total accusait, malgré de ces contraintes massives, aucune usure et était complètement en état de marche, même après le test.

2 Station de test: capacité de charge

Le test de la capacité de charge était effectué – en comparaison avec la capacité de charge déclarée – avec une **charge doublée**. Le résultat : les roulettes tenaient ferme à cette charge extrême – autant concernant qualité que mobilité.

3 Station de test: surface

Enserées dans un dispositif plateau tournant, les roulettes Ultrasoft ont été contrôlées concernant abrasion et usure à une distance de test de **plus de 5.000 m**. Le résultat : la surface Ultrasoft accusait, en comparaison avec des roulettes souples traditionnelles, un grade d'abrasion de loin insignifiant.

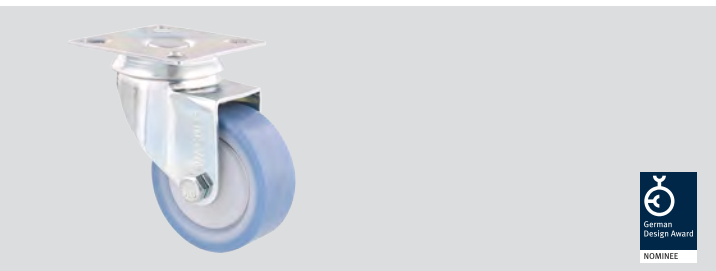

Apparate-Lenkrolle DELUXE mit Anschraubpl., Gehäuse: Ind.-stahl, verzinkt, Rad: hochw. Kunstst./TPR, Lauffläche: Ultrasoft
 Equipment swivel castor DELUXE with screw-on plate, casing: industrial steel, galvanised, wheel: high-quality plastic/TPR, tread: Ultrasoft

Roulette d'appareil pivotante DELUXE avec platine à visser, support : acier industriel, zingué, roue : plastique de haute qualité/TPR, surface : Ultrasoft



50	20	ULTRA soft	72	23	50x50	35	6	50	1x	PE	Code	EAN-Code
50	20	X	72	23	50x50	35	6	50	X		03 1751 01	...052558
75	25	X	100	35	60x60	43	6	75	X		03 1776 01	...052602

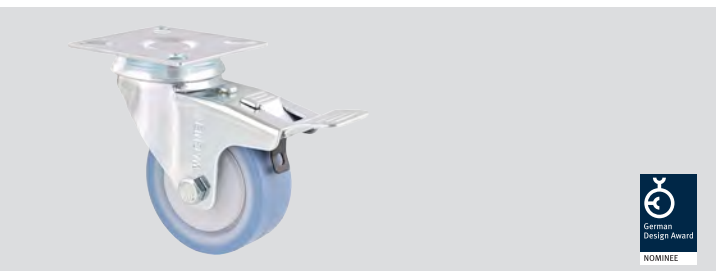

App.-Lenkrolle DELUXE mit Anschraubp. u. T-Festst., Gehäuse: Ind.stahl, verzinkt, Rad: hochw. Kunstst./TPR, Lauffl.: Ultrasoft
 Equipment swivel castor DELUXE with screw-on plate and total brake, casing: industrial steel, galvanised, wheel: high-quality plastic/TPR, tread: Ultrasoft

Roulette d'appareil pivotante DELUXE avec platine à visser et blocage total, support : acier industriel, zingué, roue : plastique de haute qualité/TPR, surface : Ultrasoft



50	20	ULTRA soft	72	23	50x50	35	6	50	1x	PE	Code	EAN-Code
50	20	X	72	23	50x50	35	6	50	X		03 3751 01	...052619
75	25	X	100	35	60x60	43	6	75	X		03 3776 01	...052626



Apparate-Bockrolle DELUXE mit Anschraubpl., Gehäuse: Ind.-stahl, verzinkt, Rad: hochw. Kunstst.; TPR, Lauffläche: Ultrasoft
 Equipment fixed castor DELUXE with screw-on plate, casing: industrial steel, galvanised, wheel: high-quality plastic/TPR, tread: Ultrasoft

Roulette d'appareil fixe DELUXE avec platine à visser, support : acier industriel, zingué, roue : plastique de haute qualité/TPR, surface : Ultrasoft



50	20	ULTRA soft	72	50x50	35	6	50	1x	PE	Code	EAN-Code
50	20	X	72	50x50	35	6	50	X		23 7751 01	...052633
75	25	X	100	60x60	43	6	75	X		23 7776 01	...052640



Ersatzrad für Apparaterolle DELUXE, Rad: hochwertiger Kunststoff/TPR, Lauffläche: Ultrasoft

Spare wheel for equipment castor DELUXE, wheel: high-quality plastic/TPR, tread: Ultrasoft

Roue de rechange pour roulette d'appareil DELUXE, roue : plastique de haute qualité/TPR, surface : Ultrasoft

														1x			Code	EAN-Code
50	20	X	X	X	6	26	50							X			03 6751 01	...405644
75	25	X	X	X	6	32	75							X			03 6776 01	...405651

Befesti

gungen

Fixing elements

Fixations

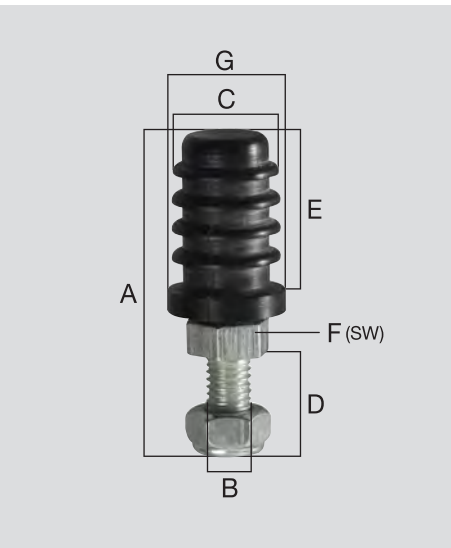

Stift verzinkt, mit Rundrohrhülse Ø 17 mm / Ø 20 mm
 Galvanised stem, with round cap Ø 17 mm / Ø 20 mm
 Tige zinguée, avec douille ronde Ø 17 mm / Ø 20 mm



A	B	C	D	E	F	G	1x			Code	EAN-Code 4001073 ...
52	8	17	15	26	13	20	X			13 0383 01	...034912

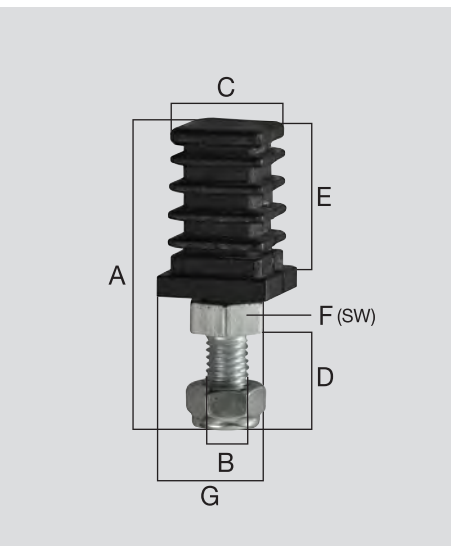

Stift verzinkt, mit Vierkanthülse 17x17mm / 20x20mm
 Galvanised stem, with square cap 17x17mm / 20x20mm
 Tige zinguée, avec douille carée 17x17mm / 20x20mm



A	B	C	D	E	F	G	1x			Code	EAN-Code 4001073 ...
55	8	17	15	26	13	20	X			13 0384 01	...035018

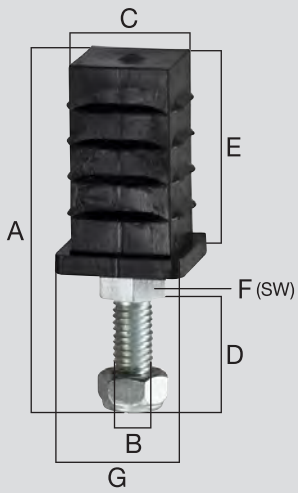

Stift verzinkt, mit Vierkanthülse 22x22mm / 25x25mm
 Galvanised stem, with square cap 22x22mm / 25x25mm
 Tige zinguée, avec douille carée 22x22mm / 25x25mm



A	B	C	D	E	F	G	1x			Code	EAN-Code 4001073 ...
66	8	22	15	35	13	25	X			13 0385 01	...035117

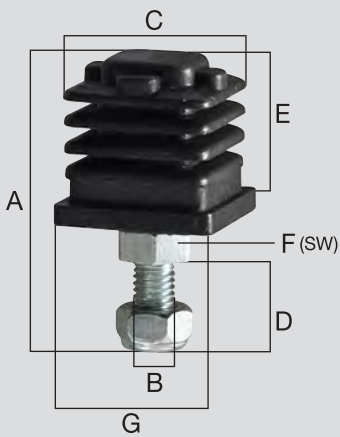

Stift verzinkt, mit Vierkanthülse 27x27mm / 30x30mm
 Galvanised stem, with square cap 27x27mm / 30x30mm
 Tige zinguée, avec douille carée 27x27mm / 30x30mm



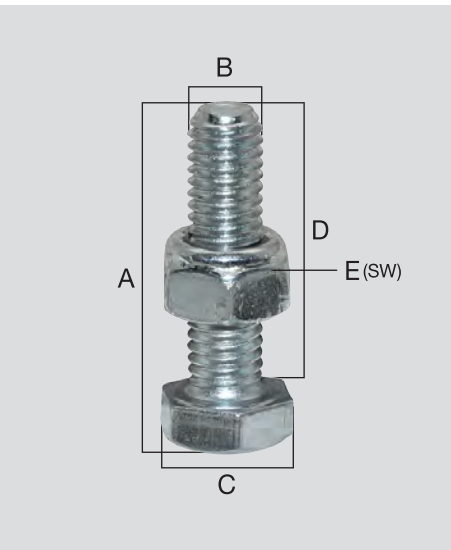

A	B	C	D	E	F	G	1x			Code	EAN-Code 4001073 ...
52	8	27	15	26	13	30	X			13 0386 01	...035216



Gewindestift verzinkt M8x30 mm / SW 13
 Galvanised threaded stem M8x30 mm / SW 13
 Tige filetée zinguée M8x30 mm / SW 13



A	B	C	D	E			1x			Code	EAN-Code 4001073 ...
35	8	13	30	13			X			13 0390 01	...035513

Gewindestift verzinkt M 10x30 mm / SW 17
 Galvanised threaded stem M 10x30 mm / SW 17
 Tige filetée zinguée M 10x30 mm / SW 17

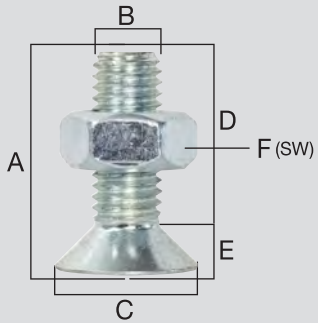

A	B	C	D	E	F		1x			Code	EAN-Code 4001073 ...
30	10	20	24	6	17		X			13 0389 01	...035414
30	10	20	24	6	17			2		13 0389 02	...015423

Transp

ortrollen

Swivel castors for transport equipment
Roulettes de transport



Transportgeräte-Lenkrolle mit Anschraubplatte, Gehäuse: Industriestahl, verzinkt, Rad: Polyamid, weiß

Swivel castor for transport equipment with screw-on plate, casing: industrial steel, galvanised, wheel: polyamide, white

Roulette de transport pivotante, avec platine à visser, support : acier industriel, zingué, roue : polyamide, blanche

Ø	h	Ø	h	Ø	Ø	Ø	Ø	kg						1x		PE	Code	EAN-Code 4001073 ...
80	35	X	107	40	84x104	56x76	9	50						X			04 6580 01	...010251
100	35	X	126	40	84x104	56x76	9	70						X			04 6500 01	...010404
125	35	X	155	40	84x104	56x76	9	100						X			04 6525 01	...010558



Transportgeräte-Lenkrolle mit Anschraubplatte und Totalfeststeller, Gehäuse: Industriestahl, verzinkt, Rad: Polyamid, weiß

Swivel castor for transport equipment with screw-on plate and total brake, casing: industrial steel, galvanised, wheel: polyamide, white

Roulette de transport pivotante, avec platine à visser et blocage total, support : acier industriel, zingué, roue : polyamide, blanche

Ø	h	Ø	h	Ø	Ø	Ø	Ø	kg						1x		PE	Code	EAN-Code 4001073 ...
80	35	X	107	40	84x104	56x76	9	50						X			04 7580 01	...010305
100	35	X	126	40	84x104	56x76	9	70						X			04 7500 01	...010442
125	35	X	155	40	84x104	56x76	9	100						X			04 7525 01	...010602

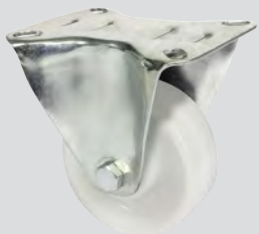

Transportgeräte-Bockrolle mit Anschraubplatte, Gehäuse: Industriestahl, verzinkt, Rad: Polyamid, weiß

Fixed castor for transport equipment with screw-on plate, casing: industrial steel, galvanised, wheel: polyamide, white

Roulette de transport fixe avec platine à visser, support : acier industriel, zingué, roue : polyamide, blanche

Ø	h	Ø	h	Ø	Ø	Ø	kg							1x		PE	Code	EAN-Code 4001073 ...
80	35	X	107	84x104	56x76	9	50							X			04 8580 01	...010336
100	35	X	126	84x104	56x76	9	70							X			04 8500 01	...010459
125	35	X	155	84x104	56x76	9	100							X			04 8525 01	...010633



Ersatzrad für Transportgeräterolle, Rad: Polyamid, weiß

Spare wheel for transport equipment castor, wheel: polyamide, white

Roue de rechange pour roulette de transport, roue : polyamide, blanche

														1x			Code	EAN-Code 4001073 ...
80	35	X	12	41	50									X			04 9580 01	...010343
100	35	X	12	41	70									X			04 9500 01	...010503
125	35	X	15	50	100									X			04 9525 01	...010640

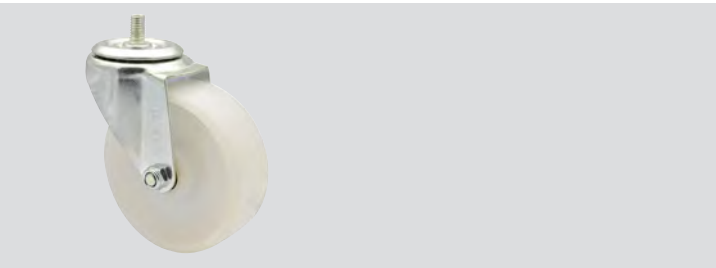

Transportgeräte-Lenkrolle mit Gewindestift, Gehäuse: Industrie-
stahl, verzinkt, Rad: Polyamid, weiß

Swivel castor for transport equipment with galvanised threaded
stem, casing: industrial steel, galvanised, wheel: polyamide, white

Roulette de transport pivotante avec tige filetée, support : acier
industriel, zingué, roue : polyamide, blanche

													1x			Code	EAN-Code
100	30	X	128	30	10x17	83	80						X			04 1111 01	4001073 ...
																	...368345

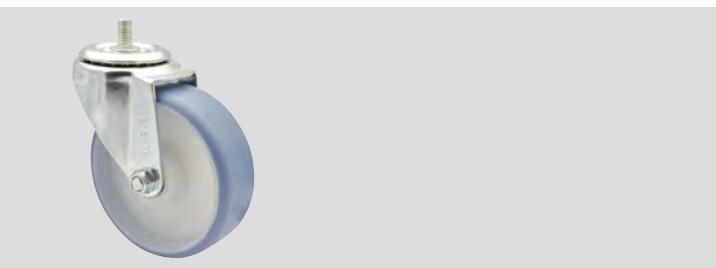

Transportgeräte-Lenkrolle mit Gewindestift, Gehäuse: Industrie-
stahl, verzinkt, Rad: hochw. Kunststoff/TPR, Lauffl.: Ultrasoft

Swivel castor for transport equipment with galvanised threaded
stem, casing: industrial steel, galvanised, wheel: high-quality
plastic/TPR, tread: Ultrasoft

Roulette de transport pivotante avec tige filetée, support : acier
industriel, zingué, roue : plastique de haute qualité/TPR,
surface : Ultrasoft

														1x			Code	EAN-Code
100	32	X	X	130	30	10x17	85	80						X			04 0210 01	4001073 ...
																		...368338

World of Wagner



„World of Wagner“ –
scannen & ansehen!



„World of Wagner“ –
scan & watch!



„World of Wagner“ –
scannez & regardez!



Transportgeräte-Lenkrolle mit Anschraubp., Gehäuse: Ind.stahl, verzinkt, Rad: hochwertiger Kunststoff/TPR, Lauffl.: Ultrasoft
Swivel castor for transport equipment with screw-on plate, casing: industrial steel, galvanised, wheel: high-quality plastic/TPR, tread: Ultrasoft

Roulette de transport pivotante, avec platine à visser, support : acier industriel, zingué, roue : plastique de haute qualité/TPR, surface : Ultrasoft

Ø	h	ULTRA soft	W	D	B	L1	L2	L3	kg				1x	PE	Code	EAN-Code 4001073 ...
80	30	X	X	106	40	84x104	56x76	9	50				X		04 6680 01	...010725
100	30	X	X	127	40	84x104	56x76	9	70				X		04 6600 01	...047424
125	36	X	X	155	40	84x104	56x76	9	100				X		04 6625 01	...047400



Transportgeräte-Lenkrolle mit Anschraubpl. u. T-Festst., Gehäuse: Ind.stahl, verzinkt, Rad: hochw. Kunstst./TPR, Lauffl.: Ultrasoft
Swivel castor for transport equipment with screw-on plate and total brake, casing: industrial steel, galvanised, wheel: high-quality plastic/TPR, tread: Ultrasoft

Roulette de transport pivotante, avec platine à visser et blocage total, support : acier industriel, zingué, roue : plastique de haute qualité/TPR, surface : Ultrasoft

Ø	h	ULTRA soft	W	D	B	L1	L2	L3	kg				1x	PE	Code	EAN-Code 4001073 ...
80	30	X	X	106	40	84x104	56x76	9	50				X		04 7680 01	...010732
100	30	X	X	127	40	84x104	56x76	9	70				X		04 7600 01	...047202
125	36	X	X	155	40	84x104	56x76	9	100				X		04 7625 01	...010954

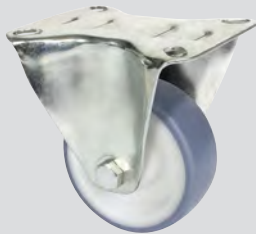

Transportgeräte-Bockrolle mit Anschraubplatte, Gehäuse: Ind.-stahl, verzinkt, Rad: hochwertiger Kunststoff/TPR, Lauffl.:Ultrasoft
Fixed castor for transport equipment with screw-on plate, casing: industrial steel, galvanised, wheel: high-quality plastic/TPR, tread: Ultrasoft

Roulette de transport fixe, avec platine à visser, support : acier industriel, zingué, roue : plastique de haute qualité/TPR, surface : Ultrasoft

Ø	h	ULTRA soft	W	D	B	L1	L2	L3	kg				1x	PE	Code	EAN-Code 4001073 ...
80	30	X	X	106	40	84x104	56x76	9	50				X		04 8680 01	...010749
100	30	X	X	127	40	84x104	56x76	9	70				X		04 8600 01	...047325
125	36	X	X	155	40	84x104	56x76	9	100				X		04 8625 01	...011555

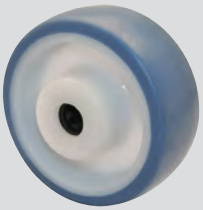

Ersatzrad für Transportgeräterolle, Rad: hochwertiger Kunststoff/TPR, Lauffläche: Ultrasoft

Spare wheel for equipment castor, wheel: high-quality plastic/TPR, tread: Ultrasoft

Roue de rechange pour roulette d'appareil, roue : plastique de haute qualité/TPR, surface : Ultrasoft

													1x			Code	EAN-Code 4001073 ...
80	30	X	X	12	41	50							X			04 9680 01	...010756
100	30	X	X	12	41	70							X			04 9600 01	...029000
125	36	X	X	15	50	100							X			04 9625 01	...011609



Transportgeräte-Lenkrolle mit Anschraubplatte, Gehäuse: Industriestahl, verzinkt, Rad: Elastik-Gummi, Lauffläche: soft

Swivel castor for transport equipment with screw-on plate, casing: industrial steel, galvanised, wheel: elastic rubber, tread: soft

Roulette de transport pivotante, avec platine à visser, support : acier industriel, zingué, roue : caoutchouc élastique, surface : soft

													1x			Code	EAN-Code 4001073 ...
80	32	X	X	107	40	84x104	56x76	9	55				X			04 6780 01	...011647
100	33	X	X	127	40	84x104	56x76	9	75				X			04 6700 01	...011753
125	36	X	X	156	40	84x104	56x76	9	105				X			04 6725 01	...011005



Transportgeräte-Lenkrolle mit Anschraubpl. u. T-Festst., Gehäuse: Ind.stahl, verzinkt, Rad: Elastik-Gummi, Lauffläche: soft

Swivel castor for transport equipment with screw-on plate and total brake, casing: industrial steel, galvanised, wheel: elastic rubber, tread: soft

Roulette de transport pivotante, avec platine à visser et blocage total, support : acier industriel, zingué, roue : caoutchouc élastique, surface : soft

													1x			Code	EAN-Code 4001073 ...
80	32	X	X	107	40	84x104	56x76	9	55				X			04 7780 01	...011654
100	33	X	X	127	40	84x104	56x76	9	75				X			04 7700 01	...011807
125	36	X	X	156	40	84x104	56x76	9	105				X			04 7725 01	...011029

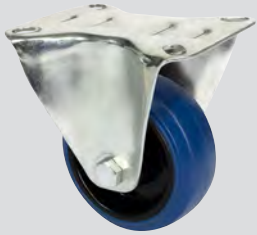

Transportgeräte-Bockrolle mit Anschraubplatte, Gehäuse: Industriestahl, verzinkt, Rad: Elastik-Gummi, Lauffläche: soft

Fixed castor for transport equipment with screw-on plate, casing: industrial steel, galvanised, wheel: elastic rubber, tread: soft

Roulette fixe de transport, avec platine à visser, support : acier industriel, zingué, roue : caoutchouc élastique, surface : soft

													1x			Code	EAN-Code 4001073 ...
80	32	X	X	107	84x104	56x76	9	55					X			04 8780 01	...011708
100	33	X	X	125	84x104	56x76	9	75					X			04 8700 01	...011814
125	36	X	X	156	84x104	56x76	9	105					X			04 8725 01	...011906



Transportgeräte-Lenkrolle mit Anschraubpl., Gehäuse: Industriestahl, verzinkt, Rad: hochw. Kunststoff (PUR), rot, Lauffläche: soft
 Swivel castor for transport equipment with screw-on plate, casing: industrial steel, galvanised, wheel: high-quality plastic (PUR), red, tread: soft

Roulette de transport pivotante, avec platine à visser, support : acier industriel, zinguée, roue : plastique de haute qualité (PUR), rouge, surface : soft

80	100	125	80	100	125	80	100	125	kg	1x	PE	Code	EAN-Code 4001073 ...
X	X	X	X	X	X	X	X	X	55	X		04 6880 01	...011142
X	X	X	X	X	X	X	X	X	75	X		04 6800 01	...011258
X	X	X	X	X	X	X	X	X	105	X		04 6825 01	...011401



Transportgeräte-Lenkrolle mit Anschraubpl. u. T-Festst., Gehäuse: Ind.stahl, verzinkt, Rad: hochw.Kunstst. (PUR), rot, Lauffläche: soft
 Swivel castor for transport equipment with screw-on plate and total brake, casing: industrial steel, galvanised, wheel: high-quality plastic (PUR), red, tread: soft

Roulette de transport pivotante, avec platine à visser et blocage total, support : acier industriel, zingué, roue : plastique de haute qualité (PUR), rouge, surface : soft

80	100	125	80	100	125	80	100	125	kg	1x	PE	Code	EAN-Code 4001073 ...
X	X	X	X	X	X	X	X	X	55	X		04 7880 01	...011159
X	X	X	X	X	X	X	X	X	75	X		04 7800 01	...011302
X	X	X	X	X	X	X	X	X	105	X		04 7825 01	...011425

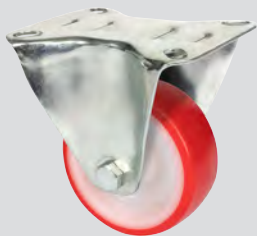

Transportgeräte-Bockrolle mit Anschraubpl., Gehäuse: Industriestahl, verzinkt, Rad: hochw. Kunststoff (PUR), rot, Lauffläche: soft
 Fixed castor for transport equipment, with screw-on plate, casing: industrial steel, galvanised, wheel: high-quality plastic (PUR), red, tread: soft

Roulette de transport fixe, avec platine à visser, support : acier industriel, zingué, roue : plastique de haute qualité (PUR), rouge, surface : soft

80	100	125	80	100	125	80	100	125	kg	1x	PE	Code	EAN-Code 4001073 ...
X	X	X	X	X	X	X	X	X	55	X		04 8880 01	...011203
X	X	X	X	X	X	X	X	X	75	X		04 8800 01	...011326
X	X	X	X	X	X	X	X	X	105	X		04 8825 01	...011432



Ersatzrad für Transportgeräterolle, Rad: hochwertiger Kunststoff, (PUR) rot, Lauffläche: soft

Spare wheel for castor for transport equipment, wheel: high-quality plastic (PUR), red, tread: soft

Roue de rechange pour roulette de transport, roue : plastique de haute qualité (PUR), rouge, surface : soft

													1x			Code	EAN-Code 4001073 ...
80	30	X	X	12	40	55							X			04 9880 01	...011227
100	30	X	X	12	40	75							X			04 9800 01	...011333
125	35	X	X	15	50	105							X			04 9825 01	...011449



Transportgeräte-Lenkrolle mit Anschraubplatte, Gehäuse: Ind. stahl, verzinkt, Rad: hochw. Kunstst. (PUR), Lauffl. soft

Swivel castor for transport equipment with screw-on plate, casing: industrial steel, galvanised, wheel: high-quality plastic (PUR), tread: soft

Roulette de transport pivotante, avec platine à visser, support : acier industriel, zingué, roue : plastique de haute qualité (PUR), surface : soft

													1x			Code	EAN-Code
125	37	X	X	153	39	106x86	78x60	9,5	300				X			04 0125 01	4001073 ...
																	...218022



Transportgeräte-Lenkrolle mit Anschraubpl. und Feststeller, Gehäuse: Ind.stahl, verzinkt, Rad: hochw. Kunstst. (PUR), Lauffl. soft

Swivel castor for transport equipment with screw-on plate and brake, casing: industrial steel, galvanised, wheel: high-quality plastic (PUR), tread: soft

Roulette de transport pivotante, avec platine à visser et blocage, support : acier industriel, zingué, roue : plastique de haute qualité (PUR), surface : soft

													1x			Code	EAN-Code
125	37	X	X	153	39	106x86	78x60	9,5	300				X			04 0225 01	4001073 ...
																	...416336



Transportgeräte-Bockrolle mit Anschraubpl., Gehäuse: Ind.stahl, verzinkt, Rad: hochw. Kunstst. (PUR), Lauffl. soft

Fixed castor for transport equipment with screw-on plate, casing: industrial steel, galvanised, wheel: high-quality plastic (PUR), tread: soft

Roulette de transport fixe, avec platine à visser, support : acier industriel, zingué, roue : plastique de haute qualité (PUR), surface : soft

													1x			Code	EAN-Code
125	37	X	X	153	106x86	78x60	9,5	300					X			04 0325 01	4001073 ...
																	...218633



PIANOHAUS TRÖBGER
SEIT 1878

YAMAHA



Transportgeräte-Lenkrolle mit Anschraubplatte, Gehäuse: Ind. stahl, verzinkt, Rad: hochw. Kunstst. (PUR), Lauffl. soft

Swivel castor for transport equipment with screw-on plate, casing: industrial steel, galvanised, wheel: high-quality plastic (PUR), tread: soft

Roulette de transport pivotante, avec platine à visser, support : acier industriel, zingué, roue : plastique de haute qualité (PUR), surface : soft

													1x			Code	EAN-Code
35	25	X	X	58	15	60x60	43x43	6x12	100				X			04 6935 01	...600483



Transportgeräte-Lenkrolle mit Anschraubpl. und Feststeller, Gehäuse: Ind.stahl, verzinkt, Rad: hochw. Kunstst. (PUR), Lauffl. soft

Swivel castor for transport equipment with screw-on plate and brake, casing: industrial steel, galvanised, wheel: high-quality plastic (PUR), tread: soft

Roulette de transport pivotante, avec platine à visser et blocage, support : acier industriel, zingué, roue : plastique de haute qualité (PUR), surface : soft

													1x			Code	EAN-Code
35	25	X	X	58	15	60x60	43x43	6x12	100				X			04 7935 01	...597004

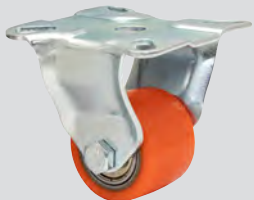

Transportgeräte-Bockrolle mit Anschraubpl., Gehäuse: Ind.stahl, verzinkt, Rad: hochw. Kunstst. (PUR), Lauffl. soft

Fixed castor for transport equipment with screw-on plate, casing: industrial steel, galvanised, wheel: high-quality plastic (PUR), tread: soft

Roulette de transport fixe, avec platine à visser, support : acier industriel, zingué, roue : plastique de haute qualité (PUR), surface : soft

													1x			Code	EAN-Code
35	25	X	X	58	60x60	43x43	6x12	100					X			04 8935 01	...398519



Transportgeräte-Lenkrolle mit Anschraubplatte, Gehäuse: Ind. stahl, verzinkt, Rad: hochw. Kunstst. (PUR), Lauffl. soft
 Swivel castor for transport equipment with screw-on plate, casing: industrial steel, galvanised, wheel: high-quality plastic (PUR), tread: soft
 Roulette de transport pivotante, avec platine à visser, support : acier industriel, zingué, roue : plastique de haute qualité (PUR), surface : soft

													1x			Code	EAN-Code
100	50	X	X	133	27	100x115	74x85	11	230				X			04 0116 01	...416244

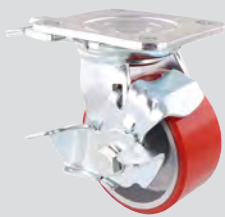

Transportgeräte-Lenk-/Bockrolle mit Anschraubpl. und Feststeller, Gehäuse: Ind.stahl, verzinkt, Rad: hochw. Kunstst. (PUR), Lauffl. soft
 Swivel / fixed castor for transport equipment with screw-on plate and brake, casing: industrial steel, galvanised, wheel: high-quality plastic (PUR), tread: soft
 Roulette de transport pivotante / fixe, avec platine à visser et blocage, support : acier industriel, zingué, roue : plastique de haute qualité (PUR), surface : soft

													1x			Code	EAN-Code
100	50	X	X	133	27	100x115	74x85	11	230				X			04 0114 01	...035094



Transportgeräte-Lenk-/Bockrolle mit Anschraubpl. und Feststeller, Gehäuse: Ind.stahl, verzinkt, Rad: hochw. Kunstst. (PUR), Lauffl. soft
 Swivel / fixed castor for transport equipment with screw-on plate and brake, casing: industrial steel, galvanised, wheel: high-quality plastic (PUR), tread: soft
 Roulette de transport pivotante / fixe, avec platine à visser et blocage, support : acier industriel, zingué, roue : plastique de haute qualité (PUR), surface : soft

													1x			Code	EAN-Code
152	50	X	X	181	40	100x115	74x85	11	400				X			04 0115 01	...417555

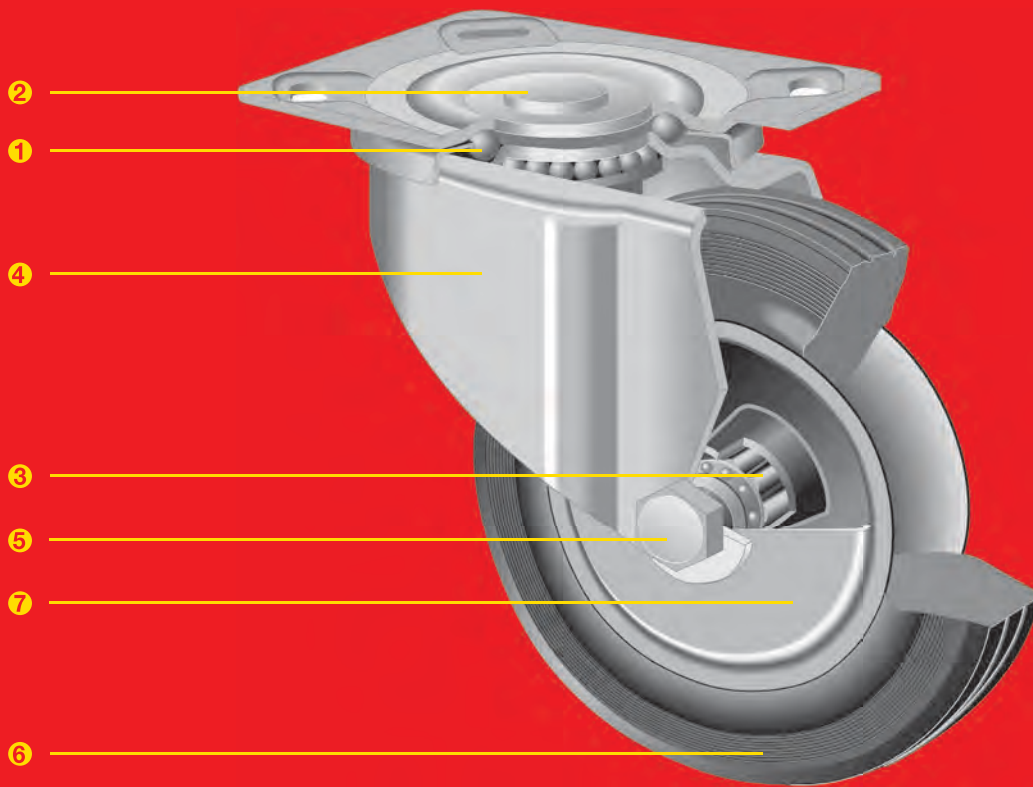

Technische Details, die Funktionalität, Sicherheit und Langlebigkeit garantieren - am Beispiel Transportgeräterolle:

- ❶ Wartungsfreies Schwenklager mit doppeltem Kugelkranz und Schwenklagerschutz, einem dicht schließenden Abdeckelement, welches das Eindringen von Schmutz, Flüssigkeiten und Fremdkörpern verhindert
- ❷ Gesicherter Rückenbolzen aus Metall, hochdruckvernietet
- ❸ Ruhiger Lauf, Stoßunempfindlichkeit und lange Lebensdauer durch ein besonders stabiles, in die Radnabe eingebautes Rollengerät
- ❹ Hochwertiges Rollengehäuse aus soliden Stahlblech-Komponenten, für maximalen Korrosionsschutz zusätzlich verzinkt
- ❺ Verschraubte Radachse für hohe Stabilität und problemlosen Austausch des Rades
- ❻ Hochabriebfeste Lauffläche des Rades, z. B. aus veredeltem Vollgummi, ideal geeignet für alle harten Böden
- ❼ Ein Fadenschutz umschließt die Radlagerung von beiden Seiten. Er verhindert das Eindringen von Schmutz und Fremdkörpern und sorgt für eine reibungslose Funktion

Technical details, functionality, safety and long life guarantee - for example a castor for transport equipment:

- ❶ Service free swivel bearing with double ball crown and swivel bearing protection, a tightly secured covering element which prevents dirt, liquids and foreign objects from entering
- ❷ Secured back bolt made of metal, high pressure welding
- ❸ Silent glide, shock resistant and long life through an extremely stable roller bearing built into the tire grooves
- ❹ High quality castor casing made of solid sheet metal components additionally galvanized for maximum corrosion protection
- ❺ Screw fastened wheel axle for strong support and easily exchangeable wheel
- ❻ Anti-smudge surface of the castor, i.e. from plain refined rubber, ideal for all hard surfaces
- ❼ A thread guard encloses the castor from both sides. It prevents dirt and foreign objects from entering, guaranteeing a smooth function

Des détails techniques qui garantissent la bonne utilisation, la sécurité et une longue durée de vie comme p. ex. pour les roulettes d'appareils:

- ❶ Roulement oscillant à double cage à billes et lèvres de protection anti-poussière contre saletés, liquides et corps étrangers
- ❷ Axe métallique à tête rivetée sous pression
- ❸ Roulage silencieux, anti chocs et longue durée de vie grâce à un moyeu spécialement stable avec cage à aiguilles intégrée
- ❹ Châssis support de roue de haute qualité en tôle d'acier galvanisée, anti-corrossif
- ❺ Boulon axe avec écrou pour une grande stabilité et un remplacement facile de la roue
- ❻ Surface de roulement très résistante à l'abrasion, p. ex. en caoutchouc plein affiné idéal pour tous sols durs
- ❼ Un dispositif pare fils enveloppant le moyeu central évite l'introduction de saletés et corps étrangers et permet un fonctionnement sans frottement

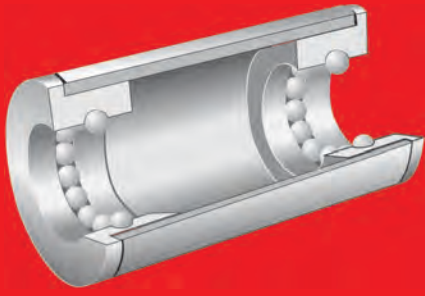

Kugellager
Ball bearing
Roulement à billes

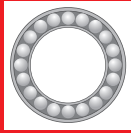

Rollenlager
Roller bearing
Palier à rouleaux

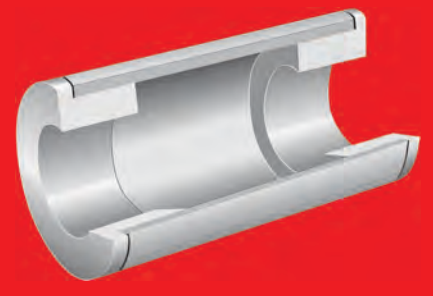
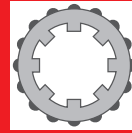

Gleitlager
Plain bearing
Palier lisse



high details

Das Kugellager erfüllt höchste Ansprüche an Tragfähigkeit und Rollwiderstand und ist damit am besten geeignet, schwere Lasten sicher zu transportieren.

The ball bearing was designed for high expectations in load capacity and roll resistance and is therefore suitable for secure transportation of heavy loads.

Le roulement à bille répond aux plus fortes exigences en matière de charge sans résistance au roulage et ainsi est le mieux adapté pour déplacer en toute sécurité des charges lourdes.

Das Rollenlager ist eine besonders robuste und hoch belastbare Lagerung. Es zeichnet sich durch Stoßunempfindlichkeit, geringen Rollwiderstand und niedrige Bauhöhe aus.

The roller bearing is an exceptionally robust and highly durable bearing. It is noted for shock resistance, minimal roll resistance and low total height.

Le palier à rouleaux est un moyen robuste et puissant d'équipement de la roulette. Il en résulte une résistance aux chocs, une facilité de roulage et une hauteur totale basse.

Rollen mit Gleitlager sind günstig, stoßunempfindlich und weitgehend wartungsfrei. Sie finden vorwiegend bei Apparate- und Transportgeräterollen Anwendung, wenn diese nicht häufig und nur auf kurzen Strecken eingesetzt werden.

Castors with a plain bearing are reasonably priced, shock resistant and almost maintenance-free. They are in use primarily with equipment castors and castors for transport equipment, if they are not often used and only on short distances.

Les roulettes avec un palier lisse ont un prix avantageux, sont insensibles aux chocs et ne nécessitent quasiment aucun entretien. Les paliers lisses s'appliquent principalement aux roulettes de transport et d'appareils si celles-ci ne sont pas souvent utilisées et uniquement pour de courts trajets.



Ersatzrad für Transportgeräterolle, Vollgummireifen mit Stahlblech-Felge

Spare wheel for transport castor, solid rubber tire with sheet-metal-rim

Roue de rechange pour roulette de transport, pneu en caoutchouc plein avec jante en tôle d'acier

		soft											1x			Code	EAN-Code 4001073 ...
80	23	X	X	12	40	60							X			04 9184 01	...013832
100	30	X	X	12	40	70							X			04 9104 01	...042511
125	35	X	X	15	50	100							X			04 9124 01	...013849



Transportgeräte-Lenkrolle mit Anschraubplatte, Gehäuse: Industriestahl, verzinkt, Vollgummireifen mit Stahlblech-Felge
 Swivel castor for transport equipment with screw-on plate, casing: industrial steel, galvanised, solid rubber tire with sheet-metal-rim
 Roulette de transport avec platine à visser, support : acier industriel, zingué, pneu en caoutchouc plein avec jante en tôle d'acier

160	39	X	X	200	55	110x139	61x84	10	150				1x		PE	Code	EAN-Code
160	39	X	X	200	55	110x139	61x84	10	150				X			04 6160 01	...009514
200	46	X	X	240	55	110x139	61x84	10	210				X			04 6200 01	...009613



Transportgeräte-Lenkrolle mit Anschraubpl. u. T.Festst., Gehäuse: Industriestahl, verzinkt, Vollgummireifen mit Stahlblech-Felge
 Swivel castor for transport equipment with screw-on plate and total brake, casing: industrial steel, galvanised, solid rubber tire with sheet-metal-rim
 Roulette de transport avec avec platine à visser et blocage total, support : acier industriel, zingué, pneu en caoutchouc plein avec jante en tôle d'acier

160	39	X	X	200	55	110x139	78x103	10	150				1x		PE	Code	EAN-Code
160	39	X	X	200	55	110x139	78x103	10	150				X			04 7160 01	...009910
200	46	X	X	240	55	110x139	78x103	10	210				X			04 7200 01	...010015



Transportgeräte-Bockrolle mit Anschraubplatte, Gehäuse: Industriestahl, verzinkt, Vollgummireifen mit Stahlblech-Felge
 Fixed castor for transport equipment with screw-on plate, casing: industrial steel, galvanised, solid rubber tire with sheet-metal-rim
 Roulette fixe de transport avec platine à visser, support : acier industriel, zingué, pneu en caoutchouc plein avec jante en tôle d'acier

160	39	X	X	200	110x139	78x103	10	150					1x		PE	Code	EAN-Code
160	39	X	X	200	110x139	78x103	10	150					X			04 8160 01	...010510
200	46	X	X	240	110x139	78x103	10	210					X			04 8200 01	...010619



Ersatzrad für Transportgeräterolle, Stahlblech-Felge, Lauffläche: soft

Spare wheel for transport equipment castor, sheet-metal-rim, tread: soft

Roue de rechange pour roulette de transport, jante en tôle d'acier, surface : soft

		soft											1x			Code	EAN-Code 4001073 ...
160	39	X	X	20	49	160							X			04 9160 01	...011517
200	50	X	X	20	60	200							X			04 9200 01	...011616

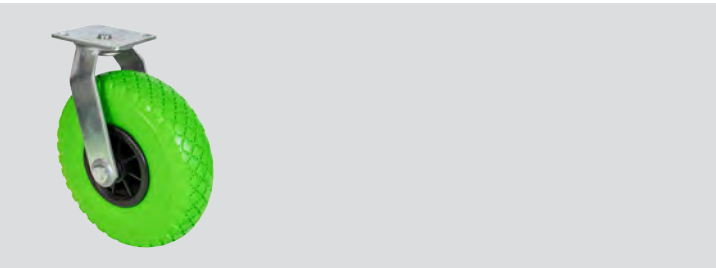

Transportgeräte-Lenkrolle mit Anschraubplatte, Gehäuse: Industriestahl, verzinkt, Rad: pannensicher aufgeschäumt, grün
 Swivel castor for transport equipment with screw-on plate, casing: industrial steel, galvanised, wheel: foamed for security against break-down, green

Roulette de transport avec platine à visser, support : acier industriel, zingué, roue : écumée, increvable, verte

													1x			Code	EAN-Code
260	75	X	X	300	65	115x100	84x68	20x11	100				X			04 8266 01	4001073 ...

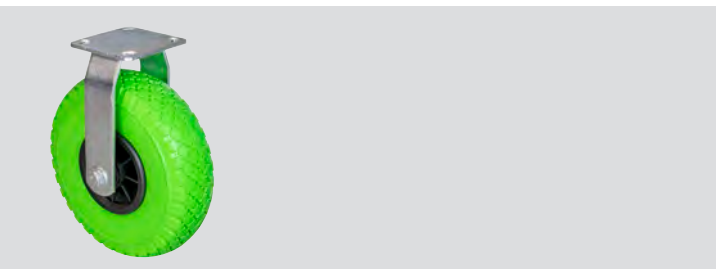

Transportgeräte-Bockrolle mit Anschraubplatte, Gehäuse: Industriestahl, verzinkt, Rad: pannensicher aufgeschäumt, grün
 Fixed castor for transport equipment with screw-on plate, casing: industrial steel, galvanised, wheel: foamed for security against break-down, green

Roulette de transport fixe avec platine à visser, support : acier industriel, zingué, roue : écumée, increvable, verte

													1x			Code	EAN-Code
260	75	X	X	300		115x100	84x68	20x11	100				X			04 7266 01	4001073 ...



Räder &

Zubehör

Wheels & accessories
Roues & accessoires



Rad, pannensicher aufgeschäumt, grau, Lauffläche: soft
 Wheel, foamed for security against break-down, grey, tread: soft
 Roue, écumée, increvable, gris, surface: soft

		soft													1x			Code	EAN-Code
200	46	X	X	8	60	75									X			04 8202 01	4001073 ...
																			...599589

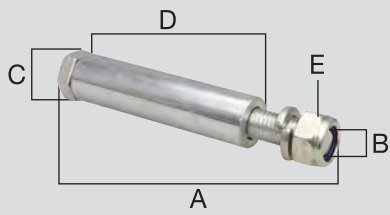

Achsmaterial
Axle material
Matériel d'axe

A	B	C	D	E											1x			Code	EAN-Code 4001073 ...
93	12	20	54	19													1	13 0441 00	...258431
118	12	20	80	19													1	13 0442 00	...092967

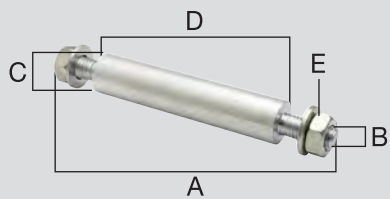

Achsmaterial
Axle material
Matériel d'axe

A	B	C	D	E											1x			Code	EAN-Code 4001073 ...
152	12	17	102	19													1	13 0444 00	... 220605
152	12	20	102	19													1	13 0443 00	... 091984
152	12	25	102	19													1	13 0445 00	...419344

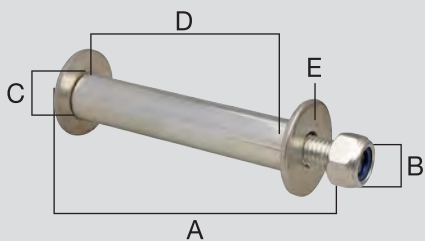

Achsmaterial für Schubkarrenräder
Axle material for wheel barrows
Matériel d'axe pour les roues des brouettes

A	B	C	D	E											1x			Code	EAN-Code 4001073 ...
135	12	20	102	19													1	13 0440 00	...060126

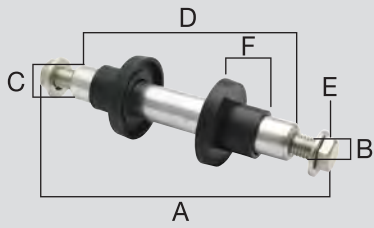

Achsmaterial
Axle material
Matériel d'axe

A	B	C	D	E	F										1x			Code	EAN-Code 4001073 ...
147	12	20	130	17	26												1	13 0446 00	...222340

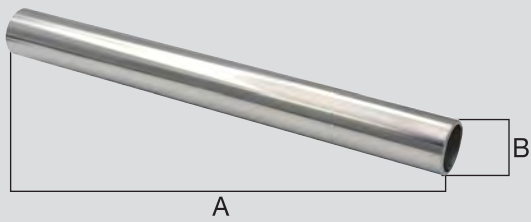

Achsen für Räder
Axles for wheels
Axes pour roues

A	B														1x			Code	EAN-Code 4001073 ...
135	20														X			13 0410 01	...045215
160	20														X			13 0411 01	...045314
190	10														X			13 0409 01	...003758
190	20														X			13 0412 01	...045413
480	20														X			13 0413 01	...045512
500	10														X			13 0415 01	...055719
800	10														X			13 0416 01	...055818
800	20														X			13 0414 01	...045611
1500	20														X			13 0417 01	...055917

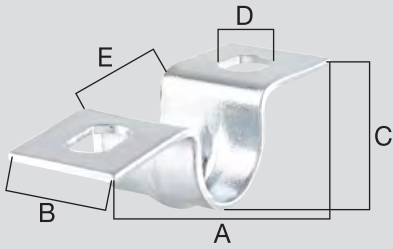

Befestigungs-Set für Achsen, Metall
 Fixing set for axles, metal
 Set de fixation pour des axes, métal

A	B	C	D	E												1x			Code	EAN-Code 4001073 ...
37	12	10	6	12												2			13 0426 99	...601893
50	12	20	6	22												2			13 0427 99	...601961

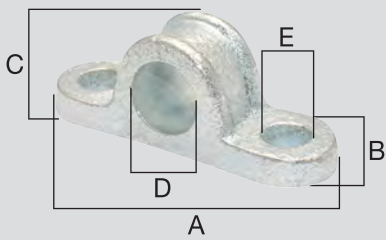

Befestigungs-Set für Achsen, Metall
 Fixing set for axles, metal
 Set de fixation pour des axes, métal

A	B	C	D	E												1x			Code	EAN-Code 4001073 ...
90	9	34	21	12												X			13 0428 01	...444339

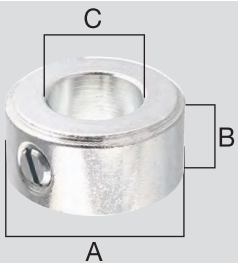

Stellringe, DIN 705, verzinkt
 Rings, DIN 705, galvanised
 Anneaux, DIN 705, zinguée

A	B	C														1x			Code	EAN-Code 4001073 ...	
20	10	10															2			13 0136 99	...601978
32	14	20															2			13 0137 99	...601985



Distanzscheiben für Achsen
 Spacer disk for axles
 Disque d'écartement pour axes

A	B	C												1x			Code	EAN-Code 4001073 ...
30	20	5													2		13 0450 99	...601992



Verschlusskappen für Achsen
 Closing caps for axles
 Chapes de fermeture pour axes

A	B													1x			Code	EAN-Code 4001073 ...
20	6	10													2		13 0418 99	...602067
38	11	20													2		13 0419 99	...602074

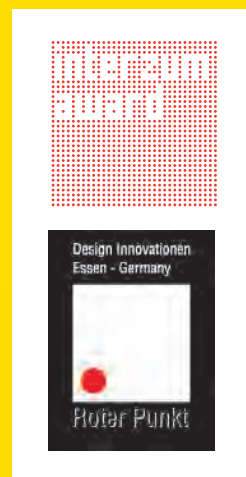
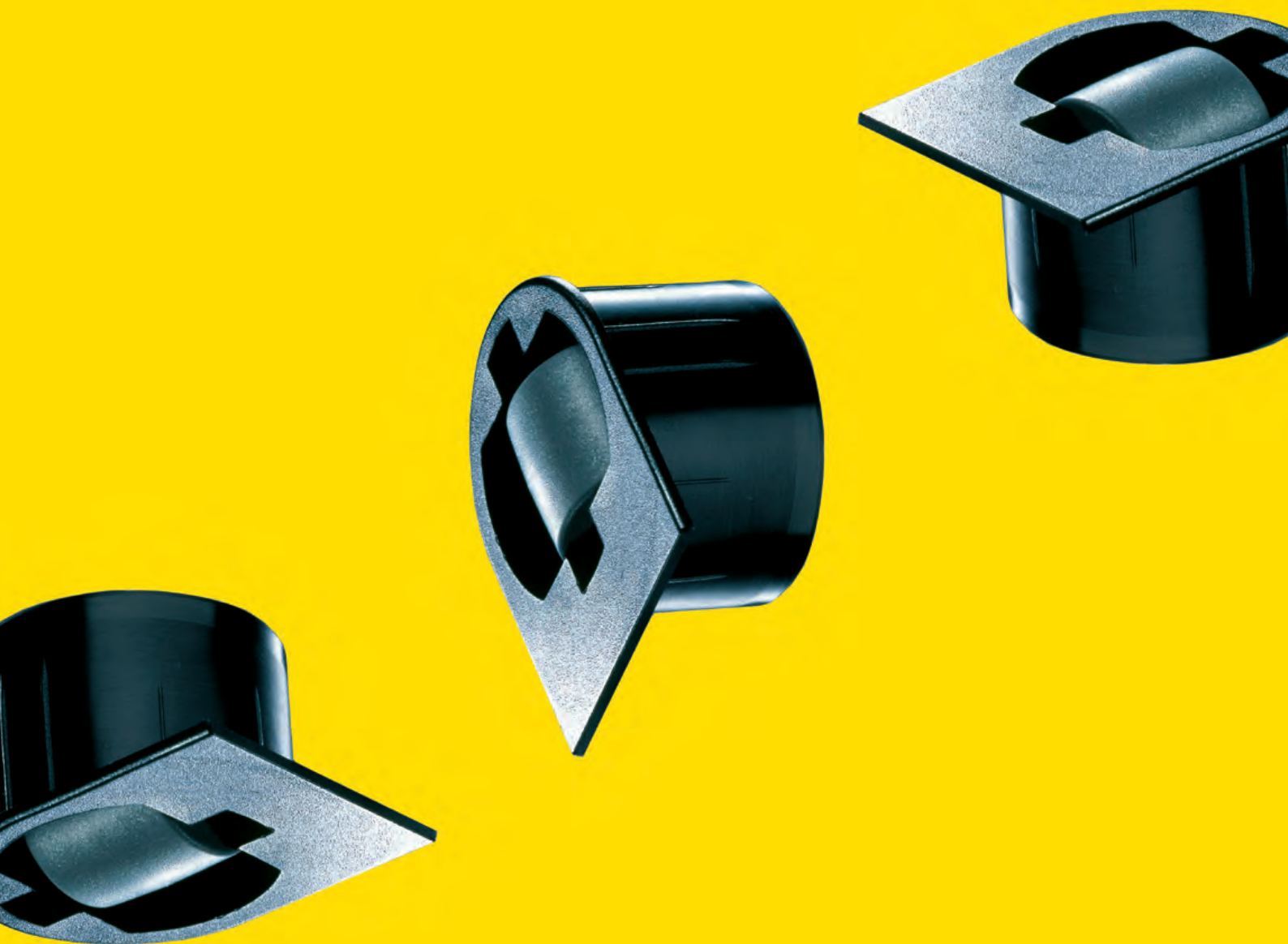

design yourself

Wagner System GmbH

Tullastraße 19, D-77933 Lahr

Phone +49 (0) 7821/9477-0, Fax +49 (0) 7821/9477-60

info@wagner-system.de, www.wagner-system.de

WAGNER®